

# LEAVE LIMITS BEHIND

PRODUCT CATALOG 2013

# 02 | Table of Contents

About Us .....	3
ADIN Packaging .....	4
ADIN Implant Systems - OverView .....	5
CloseFit™ OsseoFix™ .....	6
Touareg CloseFit™ NP/RP/WP Spiral Implants System .....	8-9
Touareg CloseFit™- NP Implant System .....	10
Touareg CloseFit™- NP Prosthetic System and Accessories .....	11-14
Touareg CloseFit™- RP Implant System .....	16
Touareg CloseFit™- RP Prosthetic System and Accessories .....	17-21
Touareg CloseFit™- WP Implant System .....	22-23
Touareg CloseFit™- RP Prosthetic System and Accessories .....	24-27
Touareg™OS/S Standard Internal Hex Spiral Implants .....	28-29
Touareg™-OS Implant System .....	30-34
Touareg™-S Implant System .....	35-39
SWELL™ Straight Implants .....	40
SWELL™ Implant System .....	41-45
Touareg™-OS, Touareg™-S, Swell™ Prosthetic Systems and Accessories .....	46-51
ONE™ Implant System .....	52-57
Surgical Kits .....	58-62
DLC (Diamond-like-carbon) Surgical Drills .....	63
Surgical Tools .....	64-65
OSSTELL ISQ .....	66
Index .....	67-70

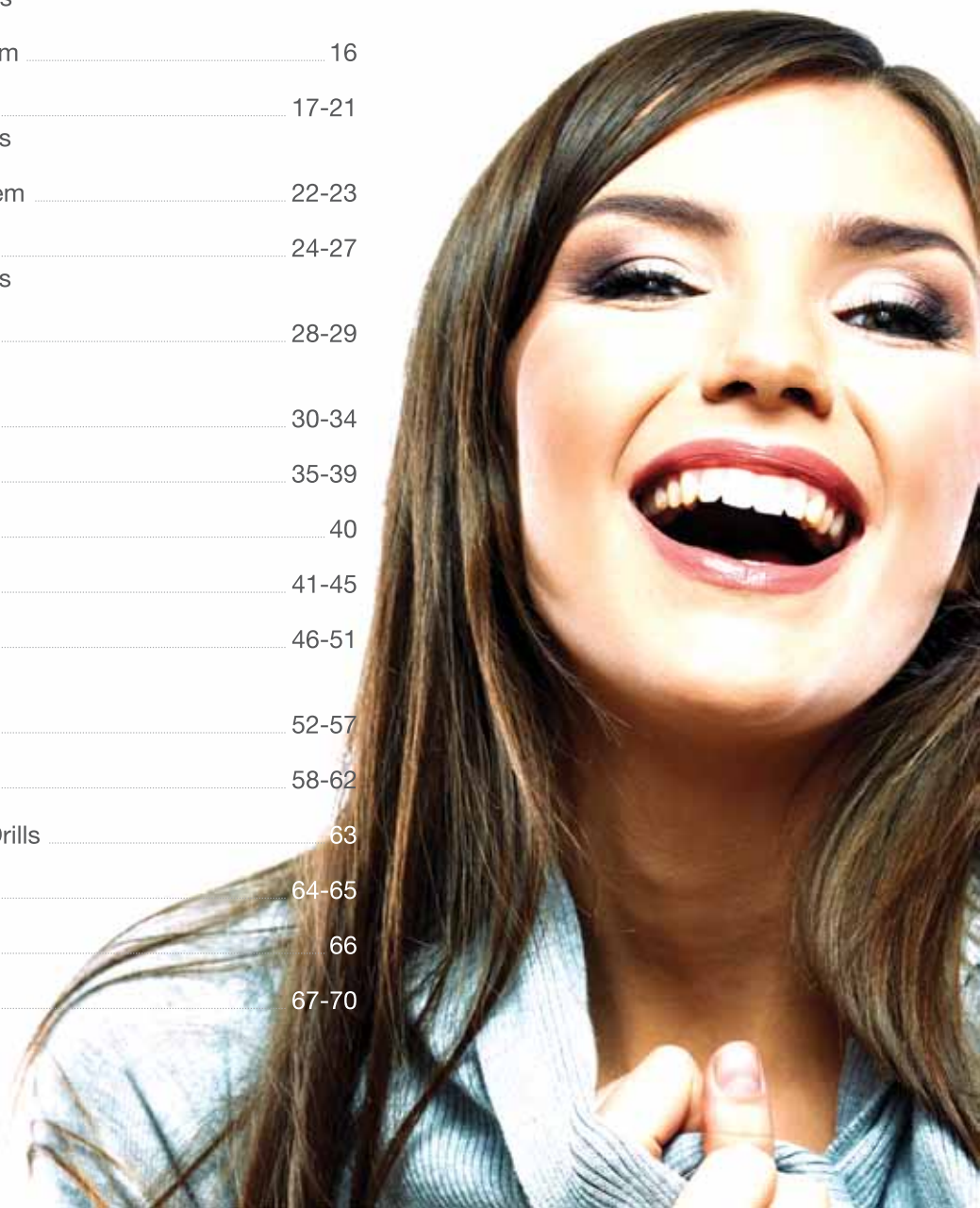

ADIN Dental Implant Systems Ltd., designs, manufactures and markets state of the art, technologically advanced dental implants solutions. For over 20 years, ADIN has provided dentists and dental technicians with innovative solutions and advanced knowledge into the field of Implant Dentistry. Located in Northern Israel, The ADIN group employs over 150 employees, each one playing a significant role in ADIN's growing success. ADIN highly values each hard working employee and attributes its growing success to their continuous dedication.

Over the years, ADIN has continuously focused on advancing its highly professional research and development team to ensure the production of technologically advanced high quality products. ADIN has also worked closely with the industry's leading dental professionals, surgeons, technicians, in both private and public sectors, along with dental schools in leading universities in order to provide customers with the most current, up-to-date industry knowledge and information.

ADIN prides itself on providing excellent customer service, constant customer communication and availability to provide continuous excellent implantology solutions, from the simplest restorative case to the most complex surgical case.

ADIN's commitment to education today reflects on a better future and improving overall customer satisfaction. ADIN highly values continuous education, offering customers new research opportunities to explore and review new ideas in the field of Implantology.

Currently, ADIN is running a prospective multi-center study to validate the survival rates, bone remodeling, and soft tissue maintenance of all dental implant systems.

With high quality implants, great customer service and a leading research and development team, ADIN is the perfect recipe for success.



Implant's diameter is color coded



**TOUAREG CloseFit™ Implant System**  
 Conical Morse Taper Connection with OsseoFix™ -  
 Calcium Phosphate Blast Surface Treatment

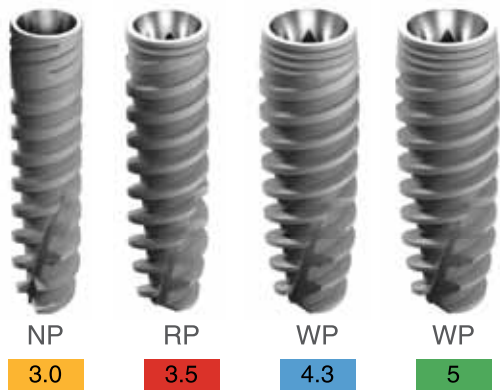

**STANDARD INTERNAL HEX Implant Systems**  
 with AB/AE- Alumina Oxide Blast/Acid  
 Etched Surface Treatment

**TOUAREG™-S**

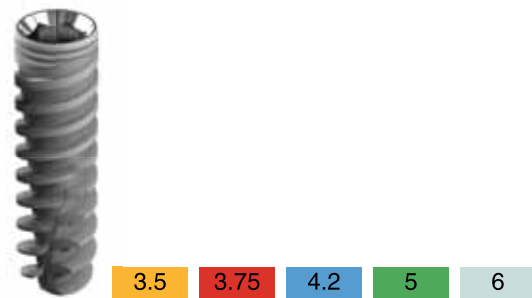

**TOUAREG™-OS**

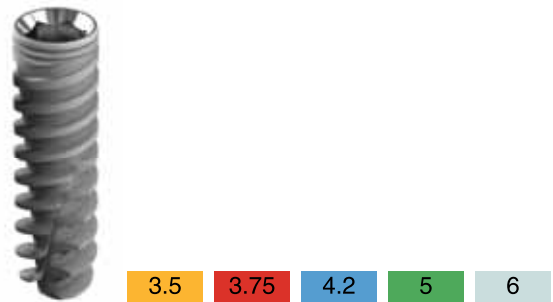

**SWELL™**

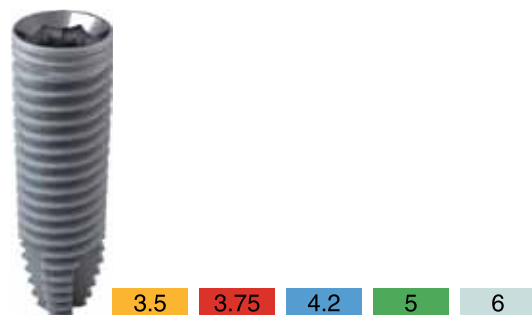

**ONE™**

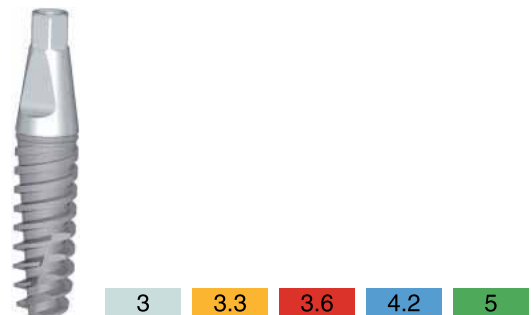

## OsseoFix™ for Touareg™ Spiral Implants - Improved Pure Titanium Surface

During the past 15 years, ADIN has followed several research studies conducted in order to discover the optimal implant surface treatment. Proper implant surface is needed to attain correct surface roughness and highest purity levels in order to achieve optimal osseointegration, increase the success rate of Bone to Implant Contact (BIC), increase the healing process and growth tissue around the implant while eliminating possibilities of infections post-surgery.

ADIN Dental Implant Systems has developed a highly successful implant surface treatment, OsseoFix™. OsseoFix™ is a pure titanium implant surface that uses calcium phosphate, a biocompatible resorbable blast media (RBM), that is debris free and has proven to achieve the desired roughness levels needed for optimal osseointegration and attain highest implant surface purity levels. The chemical composition of the OsseoFix™ surface is enriched with Calcium, Phosphor and Oxygen. The OsseoFix™ is biocompatible and osseoconductive.

### OsseoFix™ Pure Titanium Surface Treatment ADVANTAGES:

- Biocompatible resorbable material creating a pure and clean surface texture
- Faster healing process
- Increases optimal osseointegration
- Increases long term success

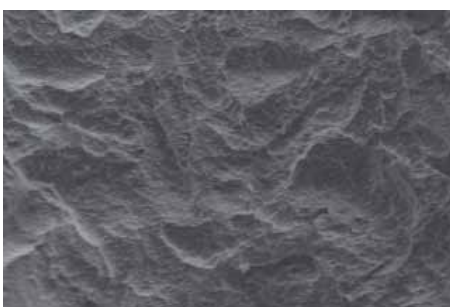

Cutting Edge Technology



LEAVE  
LIMITS  
BEHIND

# 08

# TOUAREG CloseFit™ NP/RP/WP

## ADIN's Touareg CloseFit™ Conical Hex Morse Taper Connection

The Touareg CloseFit™ Spiral Implant System offers a unique, strong and solid conical-hex connection. The conical-hex connection enables implants to be used in all indications and regions in the lower and upper jaw. The Morse Taper connection minimizes micro movements between the implant and abutment.

Touareg CloseFit™ Spiral Implant System is tapered core implants with a spiral tap, promoting immediate stability. With their unique tip and double lead thread design (2x1.2mm), these implants slice through bone unlike conventional self-tapping implants, which scrape the bone away as they tap.

By repositioning bone as it is being inserted, Touareg CloseFit™ implants can be placed at different angles for exceptional primary stability and optimal restorative orientation, along with improved esthetics with a better loading distribution.

All Touareg CloseFit™ implants feature the OsseoFix™ surface treatment proven to achieve the desired roughness levels needed for optimal osseointegration, increase the success rate of Bone to Implant Contact (BIC) and attain the highest implant surface purity levels.

	L-8mm	L-10mm	L-11.5mm	L-13mm	L-15mm	L-16mm	L-18mm
NP-3.0mmD		ISPNP1030	ISPNP1130	ISPNP1330		ISPNP1630	ISPNP1830
RP-3.5mmD	ISPX0838	ISPX1035	ISPX1135	ISPX1335	ISPX1535		ISPX1835
WP-4.3mmD	ISPX0843	ISPX1043	ISPX1143	ISPX1343	ISPX1543		ISPX1843
WP-5.0mmD	ISPX0849	ISPX1049	ISPX1149	ISPX1349	ISPX1549		ISPX1849



**Touareg CloseFit™ Advantages:**

- High primary stability, also in Type IV bone
- Self-drilling , self-cutting
- Double lead threads (2mm x 1.2mm)
- Redirecting capability for more accurate implant placement
- Built-in platform switching and a strong CloseFit™ connection
- Requires minimally invasive surgery
- Immediate function capability in all bone types

\* OsseoFix™ Surface Treatment





TOUAREG™-WP ▶  
4.3/5.0mmD  
Wide Platform  
for wide/large  
ridges and spaces

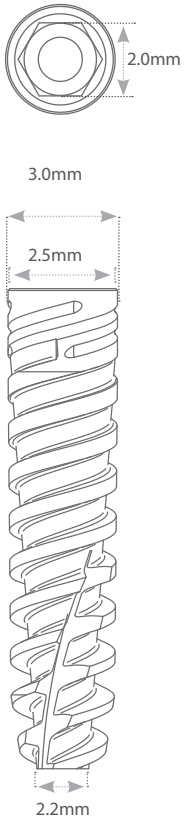

◀ TOUAREG™-NP  
3.0mmD  
Narrow Platform  
for narrow ridges  
and tight places

◀ TOUAREG™-RP  
3.5mmD  
Regular Platform  
for standard size  
ridges and places

## TOUAREG CloseFit™-NP 3.0mmD

	Catalog No.	Length	Surface	
	ISPNP1030	10	OsseoFix™ Ti Grade 5	
	ISPNP1130	11.5		
	ISPNP1330	13		
	ISPNP1630	16		
	ISPNP1830	18		

### Drill Sequence

BONE TYPE D-IV	BONE TYPE D-II & III	BONE TYPE D-I
1. 2.0	1. 2.0 2. (2.8)*	1. 2.0 2. 2.8

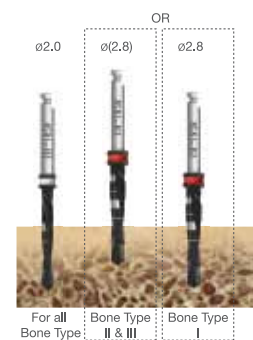















Note: (x.xx) drill to the depth of the cortex only. All Measurements are in mm.

⚠ CAUTION: The drill preparation is up to 1mm longer than the implants.

\* For initial drilling, you may use 2, 2.8 and 3.2 drills in sequence instead of the Tri-Step drill.



Healing Abutments

	NP0046	NP Slim Healing Abutment 3mmD x 2mmL	Ti Grade 5
	NP0047	NP Slim Healing Abutment 3mmD x 3mmL	Ti Grade 5
	NP0048	NP Slim Healing Abutment 3mmD X 4mmL	Ti Grade 5
	NP0049	NP Slim Healing Abutment 3mmD X 5mmL	Ti Grade 5
	NP0050	NP Slim Healing Abutment 3mmD X 6mmL	Ti Grade 5
	NP0004	NP Healing Abutment 4.5mmD X 2mmL	Ti Grade 5
	NP0008	NP Healing Abutment 4.5mmD X 3mmL	Ti Grade 5
	NP0009	NP Healing Abutment 4.5mmD X 4mmL	Ti Grade 5
	NP0012	NP Healing Abutment 4.5mmD X 5mmL	Ti Grade 5
	NP0013	NP Healing Abutment 4.5mmD X 6mmL	Ti Grade 5
	NP0090	NP Conical Healing Abutment 4.5mmD x 2mmL	Ti Grade 5
	NP0091	NP Conical Healing Abutment 4.5mmD x 3mmL	Ti Grade 5
	NP0092	NP Conical Healing Abutment 4.5mmD x 4mmL	Ti Grade 5
	NP0093	NP Conical Healing Abutment 4.5mmD x 5mmL	Ti Grade 5
	NP0094	NP Conical Healing Abutment 4.5mmD x 6mmL	Ti Grade 5



Cement Retained

	NP0010	NP Straight Slim Abutment - No End Line	Ti Grade 5
	NP0019	NP Straight Abutment 1mm	Ti Grade 5
	NP0011	NP Straight Abutment 2mm	Ti Grade 5
	NP0064	NP Straight Abutment 3mm	Ti Grade 5
	NP0015	NP Angled Abutment 15° 1mm	Ti Grade 5
	NP0026	NP Angled Abutment 15° 2mm	Ti Grade 5
	NP0063	NP Angled Abutment 15° 3mm	Ti Grade 5
	NP0018	NP Angled Abutment 15° - No End Line	Ti Grade 5
	NP0043	NP Engaging Temporary Abutment	Ti Grade 5
	NP0044	NP Non Engaging Temporary Abutment	Ti Grade 5
	NP0045	NP Plastic Cylinder Abutment	Plastic

### Cement Retained













	NP3095	NP Engaging Titanium/Plastic Abutment	Ti Grade 5 / Plastic
	NP3097	NP Non Engaging Titanium/Plastic Abutment	Ti Grade 5 / Plastic
	NP0001	NP Abutment Screw	Ti Grade 5

### Cement Retained Zirconium - Abutments

	ZA0105	NP Straight Zirconium Abutment w/Titanium Base	Zirconium/Ti Grade 5
	ZA0107	NP Angled Zirconium Abutment 15° w/Titanium Base	Zirconium/Ti Grade 5

### Screw Retained





### TMA™ - Trans Mucosal Abutment

	NP0032	NP Straight Trans Mucosal Abutment 1mm	Ti Grade 5
	NP0033	NP Straight Trans Mucosal Abutment 2mm	Ti Grade 5
	NP0034	NP Straight Trans Mucosal Abutment 3mm	Ti Grade 5
	NP0035	NP Angled Trans Mucosal Abutment 17° 3mmL	Ti Grade 5
	NP0036	NP Angled Trans Mucosal Abutment 30° 3.5mmL	Ti Grade 5
	NP0037	NP Angled Trans Mucosal Abutment 30° 5mmL	Ti Grade 5
	NP0038	NP Angled Trans Mucosal Abutment 17° 4mmL	Ti Grade 5
	RS5005	TMA Healing Cap	Ti Grade 5
	RS4900	TMA Titanium Temporary Copying	Ti Grade 5
	RS5001	TMA Plastic Casting Sleeve w/Prosthetic Screw	Plastic
	RS5004	TMA Abutment Replica	Stainless Steel
	RS5006	TMA Impression Coping Open Tray	Ti Grade 5
	RS5011	TMA Closed Tray Transfer	Ti Grade 5

### Flat Connection

	NP0030	NP Flat Connection Abutment 2mm	Ti Grade 5
	NP0031	NP Flat Connection Abutment 4mm	Ti Grade 5
	FC5515	Flat Connection Temporary Cylinder Sleeve	Ti Grade 5
	FC5737	Flat Connection Implant Replica	Stainless Steel
	FC6011	Flat Connection Castable Abutment for Centring Ring	Plastic





### Flat Connection

	FC6015	Flat Connection Titanium Retaining Screw	Ti Grade 5
	FC6013	Flat Connection Titanium Gluing Ring	Ti Grade 5
	FC6017	Flat Connection Long Laboratory Screw	Ti Grade 5
	FC6018	Flat Connection Centring Ring	Ti Grade 5
	FC5512	Flat Connection Transfer Impression Coping	Stainless Steel





### Ball Attachment - Overdentures

	NP0020	NP Ball Attachment 0.5mm	Ti Grade 5
	NP0021	NP Ball Attachment 1mm	Ti Grade 5
	NP0022	NP Ball Attachment 2mm	Ti Grade 5
	NP0023	NP Ball Attachment 3mm	Ti Grade 5
	NP0024	NP Ball Attachment 4mm	Ti Grade 5
	RS2660	Plastic Ball Cap White	Nylon
	RS2662	Plastic Ball Cap Pink Soft	Nylon
	RS2670	Titanium Ball Cap	Ti Grade 5
	RS2675SS	Stainless steel Ball Cap	Stainless Steel



### Prosthetic Hand Drivers

	RP0064	Star Hand Driver-Short	Stainless Steel
	RP0004	Star Hand Driver-Long	Stainless Steel
	RS6193	TMA/FC Female Hand Hex Driver-Short	Stainless Steel
	RS6191	TMA/FC Female Hand Hex Driver-Long	Stainless Steel

### Surgical Torque Drivers

	NP0006	NP 2mm Hex Torque Driver-Short	Stainless Steel
	NP0005	NP 2mm Hex Torque Driver-Long	Stainless Steel
	RP0065	Star Torque Driver-Short	Stainless Steel
	RP0005	Star Torque Driver-Long	Stainless Steel



### Surgical Torque Drivers

	RS6090	Torque Driver for Ball Attachment	Stainless Steel
	RS6197	TMA/FC Hex Torque Driver-Short	Stainless Steel
	RS6196	TMA/FC Hex Torque Driver-Long	Stainless Steel



### Surgical Handpiece Drivers and Adaptors

	NP0062	NP 2mm Hex Handpiece Adapter-Short	Stainless Steel
	NP0072	NP 2mm Hex Handpiece Adapter-Long	Stainless Steel
	RP0018	Star Handpiece Driver-Short	Stainless Steel
	RP0019	Star Handpiece Driver-Long	Stainless Steel
	RS6194	TMA/FC Hex Handpiece Adapter-Short	Stainless Steel
	RS6195	TMA/FC Hex Handpiece Adapter-Long	Stainless Steel

### Analog

	NP0007	NP Implant Analog	Stainless Steel
	RS5740	Ball Attachment Abutment Replica	Stainless Steel

### Transfers (Implant level)

	NP0016	NP Slim Closed Tray Transfer	Stainless Steel
	NP0017	NP Open Tray Transfer	Stainless Steel

### NP Retrieval Screw

	NP0014	NP Retrieval Screw for Abutments	Ti Grade 5
---	--------	----------------------------------	------------

### NP Implant Cover Screw

	NP0002	NP Implant Cover Screw	Ti Grade 5
---	--------	------------------------	------------

Are Measured in the Small Details ■ ■ ■

LEAVE  
LIMITS  
BEHIND

## TOUAREG CloseFit™-RP 3.5mmD

	Catalog No.	Length	Surface	
	ISPX0835	8	OsseoFix™ Ti Grade 5	
	ISPX1035	10		
	ISPX1135	11.5		
	ISPX1335	13		
	ISPX1535	15		
	ISPX1835	18		

### Drill Sequence

BONE TYPE D-IV	BONE TYPE D-II & III	BONE TYPE D-I
1. Tri-Step*	1. Tri-Step*	1. Tri-Step*











Note: (x.xx) drill to the depth of the cortex only. All Measurements are in mm.

⚠ CAUTION: The drill preparation is up to 1mm longer than the implants.

\* For initial drilling, you may use 2, 2.8 and 3.2 drills in sequence instead of the Tri-Step drill.





Healing Abutments

	RP0046	RP Slim Healing Abutment 3.5mmD x 2mmL	Ti Grade 5
	RP0047	RP Slim Healing Abutment 3.5mmD x 3mmL	Ti Grade 5
	RP0048	RP Slim Healing Abutment 3.5mmD x 4mmL	Ti Grade 5
	RP0049	RP Slim Healing Abutment 3.5mmD x 5mmL	Ti Grade 5
	RP0050	RP Slim Healing Abutment 3.5mmD x 6mmL	Ti Grade 5
	RP0022	RP Healing Abutment 4.5mmD x 2mmL	Ti Grade 5
	RP0023	RP Healing Abutment 4.5mmD x 3mmL	Ti Grade 5
	RP0024	RP Healing Abutment 4.5mmD x 4mmL	Ti Grade 5
	RP0025	RP Healing Abutment 4.5mmD x 5mmL	Ti Grade 5
	RP0026	RP Healing Abutment 4.5mmD x 6mmL	Ti Grade 5
	RP0090	RP Conical Healing Abutment 4.5mmD x 2mmL	Ti Grade 5
	RP0091	RP Conical Healing Abutment 4.5mmD x 3mmL	Ti Grade 5
	RP0092	RP Conical Healing Abutment 4.5mmD x 4mmL	Ti Grade 5
	RP0093	RP Conical Healing Abutment 4.5mmD x 5mmL	Ti Grade 5
	RP0094	RP Conical Healing Abutment 4.5mmD x 6mmL	Ti Grade 5



Cement Retained

	RP0020	RP Straight Slim Abutment - No End Line	Ti Grade 5
	RP0012	RP Straight Abutment 1mm	Ti Grade 5
	RP0011	RP Straight Abutment 2mm	Ti Grade 5
	RP0010	RP Straight Abutment 3mm	Ti Grade 5
	RP0013	RP Angled Abutment 15° 1mm	Ti Grade 5
	RP0014	RP Angled Abutment 15° 2mm	Ti Grade 5
	RP0015	RP Angled Abutment 15° 3mm	Ti Grade 5
	RP0043	RP Engaging Temporary Abutment	Ti Grade 5
	RP0044	RP Non Engaging Temporary Abutment	Ti Grade 5
	RP0045	RP Plastic Cylinder Abutment	Plastic
	RP3095	RP Engaging Titanium/Plastic Abutment	Ti Grade 5 / Plastic

### Cement Retained

	RP3097	RP Non-Engaging Titanium/Plastic Abutment	Ti Grade 5 / Plastic
	RP0001	RP Abutment Screw	Ti Grade 5

### Cement Retained- Zirconium Abutments

	ZA0214	RP Straight Zirconium Abutment w/Titanium Base	Zirconium/Ti Grade 5
	ZA0207	RP Angled Zirconium Abutment 15° w/Titanium Base	Zirconium/Ti Grade 5







### Screw Retained - Trans Mucosal Abutments (TMA™)

	RP0032	RP Straight Trans Mucosal Abutment 1mm	Ti Grade 5
	RP0033	RP Straight Trans Mucosal Abutment 2mm	Ti Grade 5
	RP0034	RP Straight Trans Mucosal Abutment 3mm	Ti Grade 5
	RP3734	RP Angled Trans Mucosal Abutment 17° 2.5mm	Ti Grade 5
	RP3735	RP Angled Trans Mucosal Abutment 30° 3mm	Ti Grade 5
	RP3737	RP Angled Trans Mucosal Abutment 17° 3.5mm	Ti Grade 5
	RP3738	RP Angled Trans Mucosal Abutment 30° 4mm	Ti Grade 5
	RS5005	TMA Healing Cap	Ti Grade 5
	RS4900	TMA Titanium Temporary Copying	Ti Grade 5
	RS5001	TMA Plastic Casting Sleeve w/Prosthetic Screw	Plastic
	RS5004	TMA Abutment Replica	Ti Grade 5
	RS5006	TMA Impression Coping Open Tray	Ti Grade 5
	RS5011	TMA Closed Tray Transfer	Ti Grade 5

### Flat Connection

















	RP0030	RP Flat Connection Abutment 2mm	Ti Grade 5
	RP0031	RP Flat Connection Abutment 4mm	Ti Grade 5
	FC5515	Flat Connection Temporary Cylinder Sleeve	Ti Grade 5
	FC5737	Flat Connection Implant Replica	Stainless Steel

**Flat Connection**



	FC6011	Flat Connection Castable Abutment for Centring Ring	Plastic
	FC6015	Flat Connection Titanium Retaining Screw	Ti Grade 5
	FC6013	Flat Connection Titanium Gluing Ring	Ti Grade 5
	FC6017	Flat Connection Long Laboratory Screw	Ti Grade 5
	FC6018	Flat Connection Centring Ring	Ti Grade 5
	FC5512	Flat Connection Transfer Impression Coping	Stainless Steel

**Ball Attachment - Overdentures**



	RP0051	RP Ball Attachment 0.5mm	Ti Grade 5
	RP0052	RP Ball Attachment 1mm	Ti Grade 5
	RP0053	RP Ball Attachment 2mm	Ti Grade 5
	RP0054	RP Ball Attachment 3mm	Ti Grade 5
	RP0055	RP Ball Attachment 4mm	Ti Grade 5
	RP0056	RP Ball Attachment 5mm	Ti Grade 5
	RS2660	Plastic Ball Cap White	Nylon
	RS2662	Plastic Ball Cap Pink Soft	Nylon
	RS2670	Titanium Ball Cap	Ti Grade 5
	RS2675SS	Stainless Steel Ball Cap	Stainless Steel

Drivers		Prosthetic Hand Drivers	
	RP0064	Star Hand Driver-Short	Stainless Steel
	RP0004	Star Hand Driver-Long	Stainless Steel
	RS6193	TMA/FC Female Hand Hex Driver-Short	Stainless Steel
	RS6191	TMA/FC Female Hand Hex Driver-Long	Stainless Steel
Surgical Torque Drivers			
	RP0065	Star Torque Driver-Short	Stainless Steel
	RP0005	Star Torque Driver-Long	Stainless Steel
	RP0067	RP 2.2mm Hex Torque Driver-Short	Stainless Steel
	RP0066	RP 2.2mm Hex Torque Driver-Long	Stainless Steel
	RS6197	TMA/FC Hex Torque Driver-Short	Stainless Steel
	RS6196	TMA/FC Hex Torque Driver-Long	Stainless Steel
	RS6090	Torque Driver for Ball Attachment	Stainless Steel
Surgical Handpiece Drivers and Adaptors			
	RP0018	Star Handpiece Driver-Short	Stainless Steel
	RP0019	Star Handpiece Driver-Long	Stainless Steel
	RP0062	RP Handpiece Hex Adapter-Short	Stainless Steel
	RP0072	RP Handpiece Hex Adapter-Long	Stainless Steel
	RS6194	TMA/FC Hex Handpiece Adapter-Short	Stainless Steel
	RS6195	TMA/FC Hex Handpiece Adapter-Long	Stainless Steel

### Analog

	RP0007	RP Implant Analog	Stainless Steel
	RS5740	Ball Attachment Abutment Replica	Stainless Steel

### Transfers

	RP0016	RP Slim Closed Tray Transfer	Stainless Steel
	RP0017	RP Open Tray Transfer	Stainless Steel







### RP Retrieval Screw

	RP3401	RP Retrieval Screw for Abutments	Ti Grade 5
--	--------	----------------------------------	------------

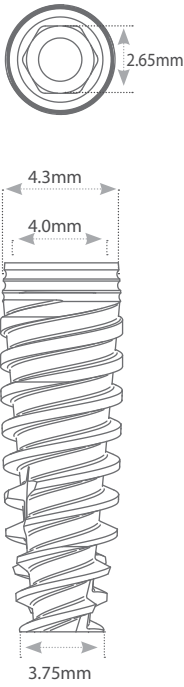
### RP Implant Cover Screw

	RP0021	RP Implant Cover Screw	Ti Grade 5
---	--------	------------------------	------------

## TOUAREG CloseFit™-WP 4.3mmD

	Catalog No.	Length	Surface	
	ISPX0843	8	OsseoFix™ Ti Grade 5	
	ISPX1043	10		
	ISPX1143	11.5		
	ISPX1343	13		
	ISPX1543	15		
	ISPX1843	18		

### Drill Sequence

BONE TYPE D-IV	BONE TYPE D-II & III	BONE TYPE D-I
1. Tri-Step* 2. (3.6)	1. Tri-Step* 2. (3.6)	1. Tri-Step* 2. 3.6







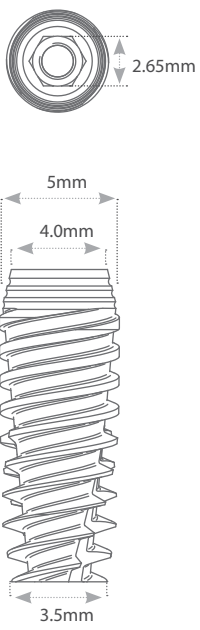

Note: (x.xx) drill to the depth of the cortex only. All Measurements are in mm.

⚠ CAUTION: The drill preparation is up to 1mm longer than the implants.

\* For initial drilling, you may use 2, 2.8 and 3.2 drills in sequence instead of the Tri-Step drill.

TOUAREG CloseFit™-WP 5.0mmD

	Catalog No.	Length	Surface	
	ISPX0849	8	OsseoFix™ Ti Grade 5	
	ISPX1049	10		
	ISPX1149	11.5		
	ISPX1349	13		
	ISPX1549	15		
	ISPX1849	18		

Drill Sequence

BONE TYPE D-IV	BONE TYPE D-II & III	BONE TYPE D-I
1. Tri-Step*	1. Tri-Step*	1. Tri-Step*
2. 3.6	2. 3.6	2. 3.6
3. (4.2)	3. 4.2	3. 4.2
	4. (4.6)	4. 4.6

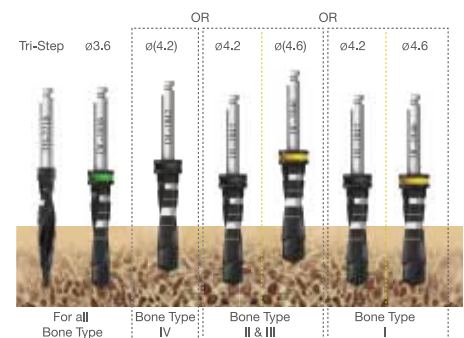















Note: (x.xx) drill to the depth of the cortex only. All Measurements are in mm.

⚠ CAUTION: The drill preparation is up to 1mm longer than the implants.

\* For initial drilling, you may use 2, 2.8 and 3.2 drills in sequence instead of the Tri-Step drill.

### Healing Abutments



	WP0046	WP Slim Healing Abutment 4mmD x 2mmL	Ti Grade 5
	WP0047	WP Slim Healing Abutment 4mmD x 3mmL	Ti Grade 5
	WP0048	WP Slim Healing Abutment 4mmD X 4mmL	Ti Grade 5
	WP0049	WP Slim Healing Abutment 4mmD X 5mmL	Ti Grade 5
	WP0050	WP Slim Healing Abutment 4mmD X 6mmL	Ti Grade 5
	WP0022	WP Healing Abutment 5.5mmD X 2mmL	Ti Grade 5
	WP0023	WP Healing Abutment 5.5mmD X 3mmL	Ti Grade 5
	WP0024	WP Healing Abutment 5.5mmD X 4mmL	Ti Grade 5
	WP0025	WP Healing Abutment 5.5mmD X 5mmL	Ti Grade 5
	WP0026	WP Healing Abutment 5.5mmD X 6mmL	Ti Grade 5
	WP0090	WP Conical Healing Abutment 4.5mmD x 2mmL	Ti Grade 5
	WP0091	WP Conical Healing Abutment 4.5mmD x 3mmL WP	Ti Grade 5
	WP0092	WP Conical Healing Abutment 4.5mmD x 4mmL	Ti Grade 5
	WP0093	WP Conical Healing Abutment 4.5mmD x 5mmL	Ti Grade 5
	WP0094	WP Conical Healing Abutment 4.5mmD x 6mmL	Ti Grade 5

### Cement Retained

	WP0020	WP Straight Slim Abutment - No End Line	Ti Grade 5
	WP0012	WP Straight Abutment 1mm	Ti Grade 5
	WP0011	WP Straight Abutment 2mm	Ti Grade 5
	WP0010	WP Straight Abutment 3mm	Ti Grade 5
	WP0013	WP Angled Abutment 15° 1mm	Ti Grade 5
	WP0014	WP Angled Abutment 15° 2mm	Ti Grade 5
	WP0015	WP Angled Abutment 15° 3mm	Ti Grade 5
	WP0043	WP Engaging Temporary Abutment	Ti Grade 5
	WP0044	WP Non Engaging Temporary Abutment	Ti Grade 5
	WP0045	WP Plastic Cylinder Abutment	Plastic
	WP3095	WP Engaging Titanium/Plastic Abutment	Ti Grade 5 / Plastic
	WP3097	WP Non Engaging Titanium/Plastic Abutment	Ti Grade 5 / Plastic
	WP0001	WP Abutment Screw	Ti Grade 5



**Cement Retained Zirconium - Abutments**

	ZA0314	WP Straight Zirconium Abutment w/Titanium Base	Zirconium/Ti Grade 5
	ZA0307	WP Angled Zirconium Abutment 15° w/Titanium Base	Zirconium/Ti Grade 5



**Screw Retained - Trans Mucosal Abutments (TMA™)**

	WP3731	WP Straight Trans Mucosal Abutment 1mm	Ti Grade 5
	WP3732	WP Straight Trans Mucosal Abutment 2mm	Ti Grade 5
	WP3733	WP Straight Trans Mucosal Abutment 3mm	Ti Grade 5
	WP3734	WP Angled Trans Mucosal Abutment 17° 2.5mm	Ti Grade 5
	WP3735	WP Angled Trans Mucosal Abutment 30° 3mm	Ti Grade 5
	WP3737	WP Angled Trans Mucosal Abutment 17° 3.5mm	Ti Grade 5
	WP3738	WP Angled Trans Mucosal Abutment 30° 4mm	Ti Grade 5
	RS5005	TMA Healing Cap	Ti Grade 5
	RS4900	TMA Titanium Temporary Copying	Ti Grade 5
	RS5001	TMA Plastic Casting Sleeve w/Prosthetic Screw	Plastic
	RS5004	TMA Abutment Replica	Ti Grade 5
	RS5006	TMA Impression Coping Open Tray	Ti Grade 5
	RS5011	TMA Closed Tray Transfer	Ti Grade 5

**Flat Connection**

	WP0030	WP Flat Connection Abutment 2mm	Ti Grade 5
	WP0031	WP Flat Connection Abutment 4mm	Ti Grade 5
	FC5515	Flat Connection Temporary Cylinder Sleeve	Ti Grade 5
	FC5737	Flat Connection Implant Replica	Ti Grade 5
	FC6011	Flat Connection Castable Abutment for Centring Ring	Plastic
	FC6015	Flat Connection Titanium Retaining Screw	Ti Grade 5
	FC6013	Flat Connection Titanium Gluing Ring	Ti Grade 5





### Flat Connection

	FC6017	Flat Connection Long Laboratory Screw	Ti Grade 5
	FC6018	Flat Connection Centring Ring	Ti Grade 5
	FC5512	Flat Connection Transfer Impression Coping	Ti Grade 5



### Ball Attachment - Overdentures

	WP0051	WP Ball Attachment 0.5mm	Ti Grade 5
	WP0052	WP Ball Attachment 1mm	Ti Grade 5
	WP0053	WP Ball Attachment 2mm	Ti Grade 5
	WP0054	WP Ball Attachment 3mm	Ti Grade 5
	WP0055	WP Ball Attachment 4mm	Ti Grade 5
	WP0056	WP Ball Attachment 5mm	Ti Grade 5
	RS2660	Plastic Ball Cap White	Nylon
	RS2662	Plastic Ball Cap Pink Soft	Nylon
	RS2670	Titanium Ball Cap	Ti Grade 5
	RS2675SS	Stainless Steel Ball Cap	Stainless Steel





### Prosthetic Hand Drivers

	RP0064	Star Hand Driver-Short	Stainless Steel
	RP0004	Star Hand Driver-Long	Stainless Steel
	RS6193	TMA/FC Female Hand Hex Driver-Short	Stainless Steel
	RS6191	TMA/FC Female Hand Hex Driver-Long	Stainless Steel

### Torque Drivers

	WP0067	WP 2.6mm Hex Torque Driver-Short	Stainless Steel
	WP0066	WP 2.6mm Hex Torque Driver-Long	Stainless Steel
	RP0065	Star Torque Driver-Short	Stainless Steel



### Torque Drivers

	RP0005	Star Torque Driver-Long	Stainless Steel
	RS6197	TMA/FC Hex Torque Driver-Short	Stainless Steel
	RS6196	TMA/FC Hex Torque Driver-Long	Stainless Steel
	RS6090	Torque Driver for Ball Attachment	Stainless Steel



### Handpiece Drivers and Adaptors

	RP0018	Star Handpiece Driver-Short	Stainless Steel
	RP0019	Star Handpiece Driver-Long	Stainless Steel
	WP0062	WP Handpiece Hex Adapter-Short	Stainless Steel
	WP0072	WP Handpiece Hex Adapter-Long	Stainless Steel
	RS6194	TMA/FC Hex Handpiece Adapter-Short	Stainless Steel
	RS6195	TMA/FC Hex Handpiece Adapter-Long	Stainless Steel

### Analog

	WP0007	WP Implant Analog	Stainless Steel
	RS5740	Ball Attachment Abutment Replica	Stainless Steel

### Transfers (Implant level)

	WP0016	WP Slim Cosed Tray Transfer	Stainless Steel
	WP0017	WP Open Tray Transfer	Stainless Steel

### WP Retrieval Screw

	WP3401	WP Retrieval Screw for Abutments	Ti Grade 5
---	--------	----------------------------------	------------

### WP Implant Cover Screw

	WP0021	WP Implant Cover Screw	Ti Grade 5
---	--------	------------------------	------------

# 28 | TOUAREG™ OS/S..

## Standard Internal Hex Touareg™-OS, Touareg™-S

The Touareg™-S, and Touareg™-OS Spiral Implant are tapered implants with a spiral tap that condenses the bone during placement for immediate stability. They have two large variable threads and a tapered design for accurate implant placement, self-drilling, improved esthetics and better load distribution.

The Touareg™-S and Touareg™-OS feature a special round shaped apex that pushes the bone graft with minimal harm to anatomic structures. The Touareg™-S and Touareg™-OS are very user-friendly and their unique design allows for immediate function for all bone types.

The Touareg™-S features a standard SLA - AB/AE- Alumina Oxide Blasted/Acid Etched surface treatment whereas the Touareg™-OS features the unique OsseoFix™ - Calcium Phosphate blast surface treatment.

### TOUAREG™-OS

	L-6.25mm	L-8mm	L-10mm	L-11.5mm	L-13mm	L-16mm	L-18mm
ISF-3.5mmD			ISF1035	ISF1135	ISF1335	ISF1635	ISF1835
ISF-3.75mmD		ISF0838	ISF1038	ISF1138	ISF1338	ISF1638	ISF1838
ISF-4.2mmD	ISF0642	ISF0842	ISF1042	ISF1142	ISF1342	ISF1642	ISF1842
ISF-5.0mmD	ISF0650	ISF0850	ISF1050	ISF1150	ISF1350	ISF1650	
ISF-6.0mmD	ISF0660	ISF0860	ISF1060	ISF1160	ISF1360		

### TOUAREG™-S

	L-6.25mm	L-8mm	L-10mm	L-11.5mm	L-13mm	L-16mm	L-18mm
ISPS-3.5mmD			ISPS1035	ISPS1135	ISPS1335	ISPS1635	ISPS1835
ISPS-3.75mmD		ISPS0838	ISPS1038	ISPS1138	ISPS1338	ISPS1638	ISPS1838
ISPS-4.2mmD	ISPS0642	ISPS0842	ISPS1042	ISPS1142	ISPS1342	ISPS1642	ISPS1842
ISPS-5.0mmD	ISPS0650	ISPS0850	ISPS1050	ISPS1150	ISPS1350	ISPS1650	
ISPS-6.0mmD	ISPS0660	ISPS0860	ISPS1060	ISPS1160	ISPS1360		

**Touareg™-OS and Touareg™-S ADVANTAGES:**



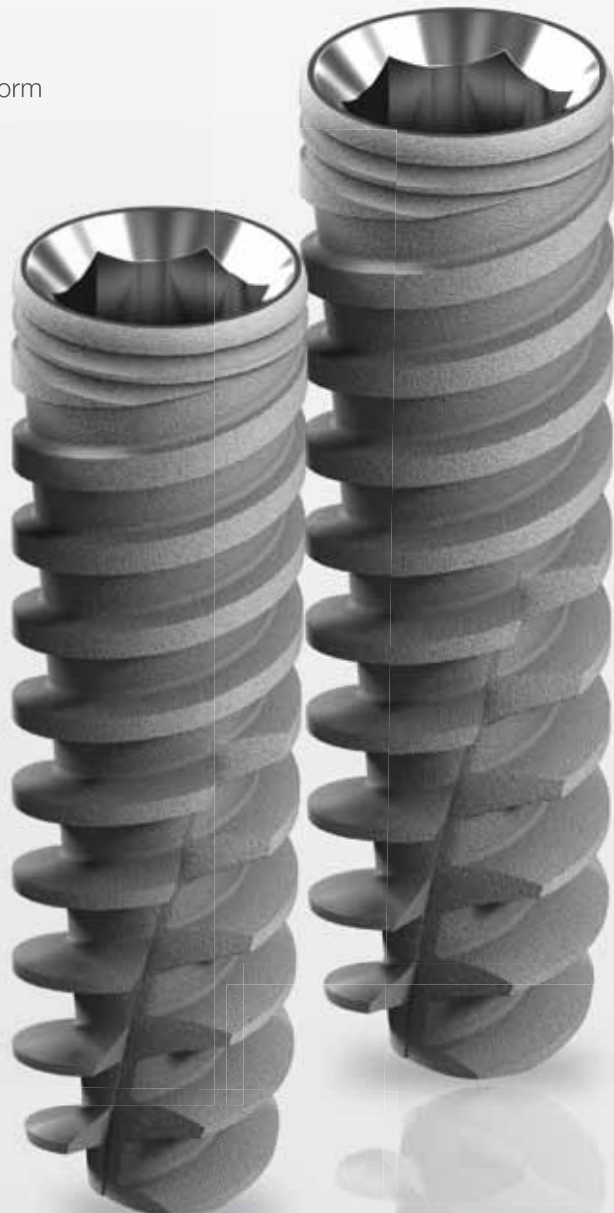

- Double lead threads (2x1.2mm)
- High primary stability, also in Type IV bone
- Bone-condensing property
- Self-drilling and self-cutting
- Redirecting capability for optimal placement
- Built-in platform switching
- Minimally invasive surgery
- Immediate function capability
- Single restorative/prosthetic platform for easy restoration

▼ TOUAREG™-OS

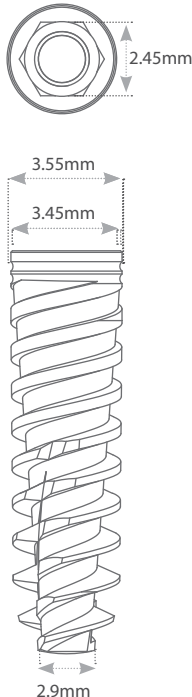

TOUAREG™-S ►

## TOUAREG™-OS 3.50mmD

	Catalog No.	Length	Surface	
	ISF1035	10	OsseoFix™ Ti Grade 5	
	ISF1135	11.5		
	ISF1335	13		
	ISF1635	16		
	ISF1835	18		

The Touareg™-OS features the unique OsseoFix™ - Calcium Phosphate blast surface treatment.

### Drill Sequence

BONE TYPE D-IV	BONE TYPE D-II & III	BONE TYPE D-I
1. Tri-Step*	1. Tri-Step*	1. Tri-Step*







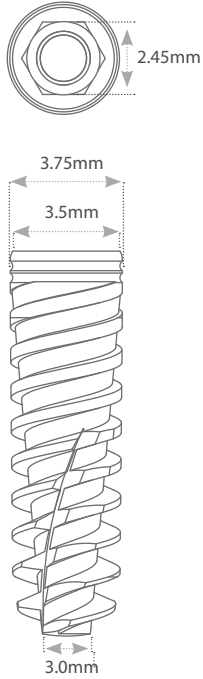

Note: (x.xx) drill to the depth of the cortex only. All Measurements are in mm.

⚠ CAUTION: The drill preparation is up to 1mm longer than the implants.

\* For initial drilling, you may use 2, 2.8 and 3.2 drills in sequence instead of the Tri-Step drill.

TOUAREG™-OS 3.75mmD

	Catalog No.	Length	Surface	
	ISF0838	8	OsseoFix™ Ti Grade 5	
	ISF1038	10		
	ISF1138	11.5		
	ISF1338	13		
	ISF1638	16		
	ISF1838	18		

Drill Sequence

BONE TYPE D-IV	BONE TYPE D-II & III	BONE TYPE D-I
1. Tri-Step*	1. Tri-Step*	1. Tri-Step*









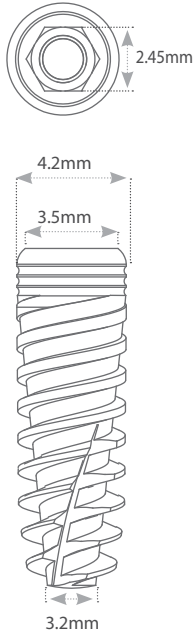

Note: (x.xx) drill to the depth of the cortex only. All Measurements are in mm.

⚠ CAUTION: The drill preparation is up to 1mm longer than the implants.

\* For initial drilling, you may use 2, 2.8 and 3.2 drills in sequence instead of the Tri-Step drill.

## TOUAREG™-OS 4.2mmD

	Catalog No.	Length	Surface	
	ISF0642	6.25	OsseoFix™ Ti Grade 5	
	ISF0842	8		
	ISF1042	10		
	ISF1142	11.5		
	ISF1342	13		
	ISF1642	16		
	ISF1842	18		
				

### Drill Sequence

BONE TYPE D-IV	BONE TYPE D-II & III	BONE TYPE D-I
1. Tri-Step* 2. (3.6)	1. Tri-Step* 2. (3.6)	1. Tri-Step* 2. 3.6









Note: (x.xx) drill to the depth of the cortex only. All Measurements are in mm.

⚠ CAUTION: The drill preparation is up to 1mm longer than the implants.

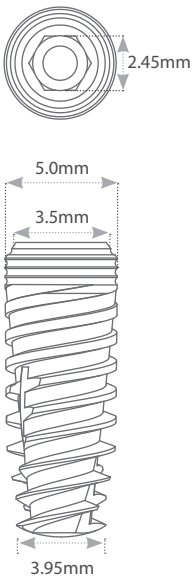
\* For initial drilling, you may use 2, 2.8 and 3.2 drills in sequence instead of the Tri-Step drill.



TOUAREG™-OS 5.0mmD

	Catalog No.	Length	Surface	
	ISF0650	6.25	OsseoFix™ Ti Grade 5	
	ISF0850	8		
	ISF1050	10		
	ISF1150	11.5		
	ISF1350	13		
	ISF1650	16		

Drill Sequence

BONE TYPE D-IV	BONE TYPE D-II & III	BONE TYPE D-I
1. Tri-Step*	1. Tri-Step*	1. Tri-Step*
2. 3.6	2. 3.6	2. 3.6
3. (4.2)	3. 4.2	3. 4.2
	4. (4.6)	4. 4.6

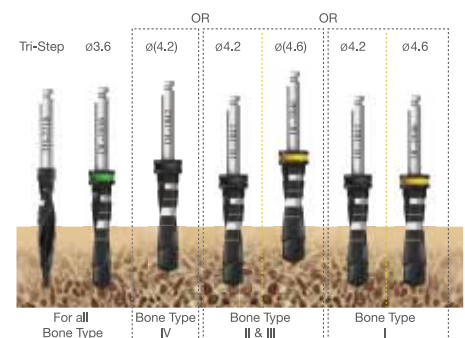

Note: (x.xx) drill to the depth of the cortex only. All Measurements are in mm.

⚠ CAUTION: The drill preparation is up to 1mm longer than the implants.

\* For initial drilling, you may use 2, 2.8 and 3.2 drills in sequence instead of the Tri-Step drill.

## TOUAREG™-OS 6.0mmD

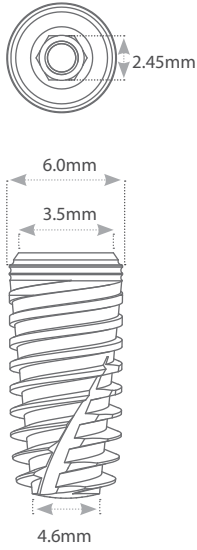
	Catalog No.	Length	Surface	
	ISF0660	6.25	OsseoFix™ Ti Grade 5	
	ISF0860	8		
	ISF1060	10		
	ISF1160	11.5		
	ISF1360	13		

## Drill Sequence

BONE TYPE D-IV	BONE TYPE D-II & III	BONE TYPE D-I
1. Tri-Step*	1. Tri-Step*	1. Tri-Step*
2. 3.6	2. 3.6	2. 3.6
3. 4.2	3. 4.2	3. 4.2
4. (5.2)	4. 5.2	4. 5.2
	5. (5.6)	5. 5.6

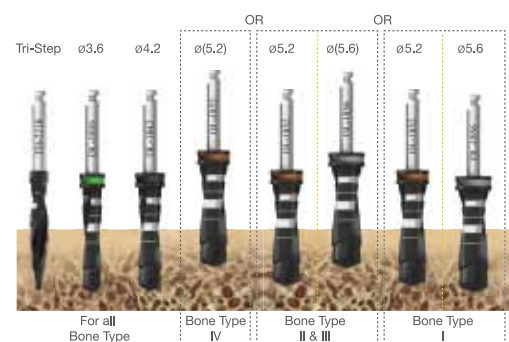





Note: (x.xx) drill to the depth of the cortex only. All Measurements are in mm.

⚠ CAUTION: The drill preparation is up to 1mm longer than the implants.

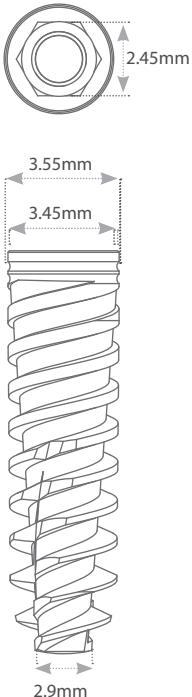
\* For initial drilling, you may use 2, 2.8 and 3.2 drills in sequence instead of the Tri-Step drill.

TOUAREG™-S 3.50mmD

	Catalog No.	Length	Surface	
	ISPS1035	10	SLA Ti Grade 5	
	ISPS1135	11.5		
	ISPS1335	13		
	ISPS1635	16		
	ISPS1835	18		

Drill Sequence

BONE TYPE D-IV	BONE TYPE D-II & III	BONE TYPE D-I
1. Tri-Step*	1. Tri-Step*	1. Tri-Step*







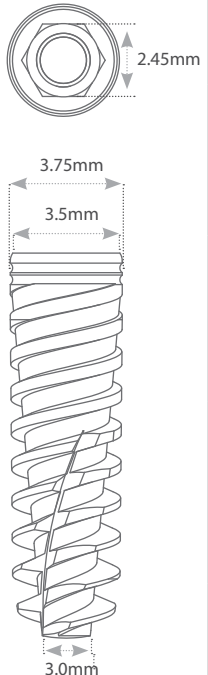

Note: (x.xx) drill to the depth of the cortex only. All Measurements are in mm.

⚠ CAUTION: The drill preparation is up to 1mm longer than the implants.

\* For initial drilling, you may use 2, 2.8 and 3.2 drills in sequence instead of the Tri-Step drill.

## TOUAREG™-S 3.75mmD

	Catalog No.	Length	Surface	
	ISPS0838	8	SLA Ti Grade 5	
	ISPS1038	10		
	ISPS1138	11.5		
	ISPS1338	13		
	ISPS1638	16		
	ISPS1838	18		

### Drill Sequence

BONE TYPE D-IV	BONE TYPE D-II & III	BONE TYPE D-I
1. Tri-Step*	1. Tri-Step*	1. Tri-Step*







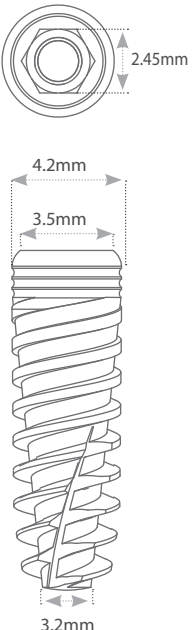

Note: (x.xx) drill to the depth of the cortex only. All Measurements are in mm.

⚠ CAUTION: The drill preparation is up to 1mm longer than the implants.

\* For initial drilling, you may use 2, 2.8 and 3.2 drills in sequence instead of the Tri-Step drill.

TOUAREG™-S 4.2mmD

	Catalog No.	Length	Surface	
	ISPS0642	6.25	SLA Ti Grade 5	
	ISPS0842	8		
	ISPS1042	10		
	ISPS1142	11.5		
	ISPS1342	13		
	ISPS1642	16		
	ISPS1842	18		

Drill Sequence

BONE TYPE D-IV	BONE TYPE D-II & III	BONE TYPE D-I
1. Tri-Step* 2. (3.6)	1. Tri-Step* 2. (3.6)	1. Tri-Step* 2. 3.6







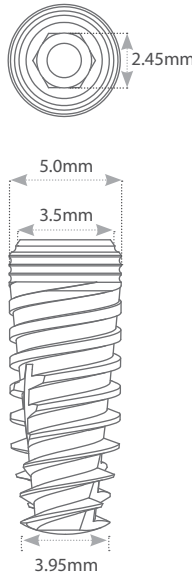

Note: (x.xx) drill to the depth of the cortex only. All Measurements are in mm.

⚠ CAUTION: The drill preparation is up to 1mm longer than the implants.

\* For initial drilling, you may use 2, 2.8 and 3.2 drills in sequence instead of the Tri-Step drill.

## TOUAREG™-S 5.0mmD

	Catalog No.	Length	Surface	
	ISPS0650	6.25	SLA Ti Grade 5	
	ISPS0850	8		
	ISPS1050	10		
	ISPS1150	11.5		
	ISPS1350	13		
	ISPS1650	16		

## Drill Sequence

BONE TYPE D-IV	BONE TYPE D-II & III	BONE TYPE D-I
1. Tri-Step*	1. Tri-Step*	1. Tri-Step*
2. 3.6	2. 3.6	2. 3.6
3. (4.2)	3. 4.2	3. 4.2
	4. (4.6)	4. 4.6

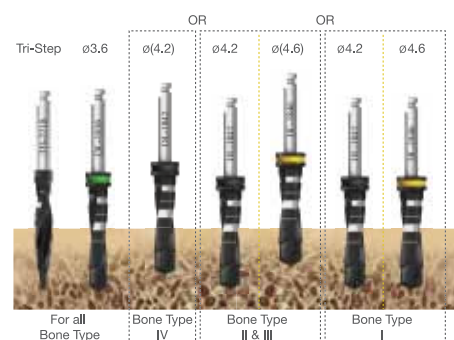





Note: (x.xx) drill to the depth of the cortex only. All Measurements are in mm.

⚠ CAUTION: The drill preparation is up to 1mm longer than the implants.

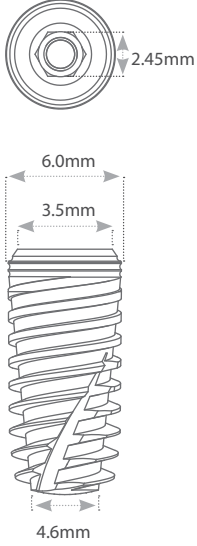
\* For initial drilling, you may use 2, 2.8 and 3.2 drills in sequence instead of the Tri-Step drill.

TOUAREG™-S 6.0mmD

	Catalog No.	Length	Surface	
	ISPS0660	6.25	SLA Ti Grade 5	
	ISPS0860	8		
	ISPS1060	10		
	ISPS1160	11.5		
	ISPS1360	13		

Drill Sequence

BONE TYPE D-IV	BONE TYPE D-II & III	BONE TYPE D-I
1. Tri-Step*	1. Tri-Step*	1. Tri-Step*
2. 3.6	2. 3.6	2. 3.6
3. 4.2	3. 4.2	3. 4.2
4. (5.2)	4. 5.2	4. 5.2
	5. (5.6)	5. 5.6

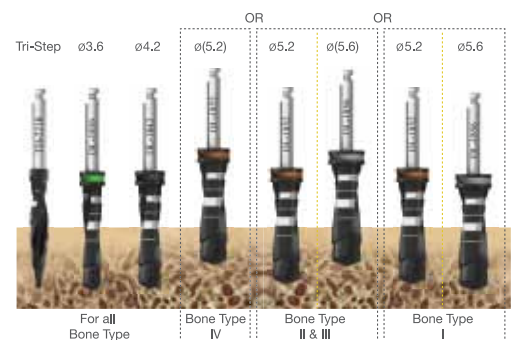

Note: (x.xx) drill to the depth of the cortex only. All Measurements are in mm.

⚠ CAUTION: The drill preparation is up to 1mm longer than the implants.

\* For initial drilling, you may use 2, 2.8 and 3.2 drills in sequence instead of the Tri-Step drill.

# 40 | SWELL™

## SWELL™ Straight Implant System

The Swell™ is a straight, parallel walled, slightly tapered implant with V-shaped thread design.

Its unique design allows for extremely accurate positioning for improved esthetics and better load distribution. The Swell™ implant features the standard SLA - AB/AE- Alumina Oxide Blasted/Acid Etched surface treatment.







SWELL™ 

	L-6.25mm	L-8mm	L-10mm	L-11.5mm	L-13mm	L-16mm	L-18mm
ID-3.3mmD			ID1033	ID1133	ID1333	ID1633	ID1833
ID-3.75mmD		ID0838	ID1038	ID1138	ID1338	ID1638	ID1838
ID-4.2mmD	ID0642	ID0842	ID1042	ID1142	ID1342	ID1642	ID1842
ID-5.0mmD	ID0650	ID0850	ID1050	ID1150	ID1350	ID1650	
ID-6.0mmD	ID0660	ID0860	ID1060	ID1160	ID1360		

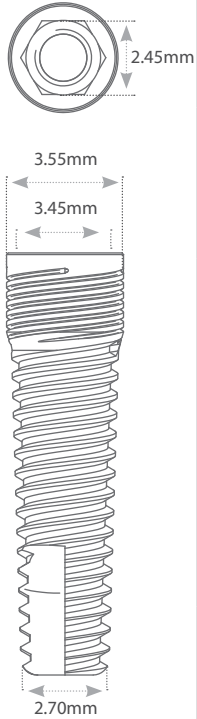

SWELL™ 3.3mmD

	Catalog No.	Length	Surface	
	ID1033	10	SLA Ti Grade 5	
	ID1133	11.5		
	ID1333	13		
	ID1633	16		
	ID1833	18		

Drill Sequence







BONE TYPE D-IV	BONE TYPE D-II & III	BONE TYPE D-I
1. 2.0 2. (2.8)	1. 2.0 2. (2.8)	1. Tri-Step*

Note: (x.xx) drill to the depth of the cortex only. All Measurements are in mm.

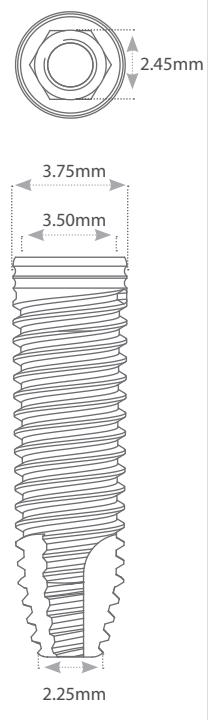
⚠ CAUTION: The drill preparation is up to 1mm longer than the implants.

\* For initial drilling, you may use 2, 2.8 and 3.2 drills in sequence instead of the Tri-Step drill.

## SWELL™ 3.75mmD

	Catalog No.	Length	Surface	
	ID0838	8	SLA Ti Grade 5	
	ID1038	10		
	ID1138	11.5		
	ID1338	13		
	ID1638	16		
	ID1838	18		
	ID1838	18		

### Drill Sequence





BONE TYPE D-IV	BONE TYPE D-II & III	BONE TYPE D-I
1. Tri-Step*	1. Tri-Step*	1. Tri-Step*

Note: (x.xx) drill to the depth of the cortex only. All Measurements are in mm.

⚠ CAUTION: The drill preparation is up to 1mm longer than the implants.

\* For initial drilling, you may use 2, 2.8 and 3.2 drills in sequence instead of the Tri-Step drill.

SWELL™ 4.2mmD

	Catalog No.	Length	Surface	
	ID0642	6,25	SLA Ti Grade 5	
	ID0842	8		
	ID1042	10		
	ID1142	11.5		
	ID1342	13		
	ID1642	16		
	ID1842	18		

Drill Sequence







BONE TYPE D-IV	BONE TYPE D-II & III	BONE TYPE D-I
1. Tri-Step*	1. Tri-Step* 2. (3.6)	1. Tri-Step* 2. 3.6

Note: (x.xx) drill to the depth of the cortex only. All Measurements are in mm.

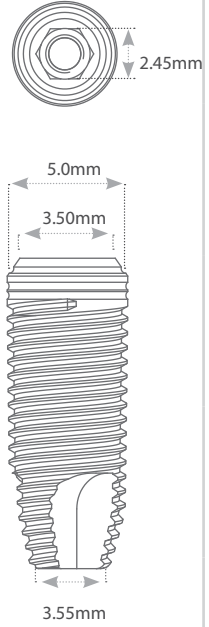
⚠ CAUTION: The drill preparation is up to 1mm longer than the implants.

\* For initial drilling, you may use 2, 2.8 and 3.2 drills in sequence instead of the Tri-Step drill.

## SWELL™ 5.0mmD

	Catalog No.	Length	Surface	
	ID0650	6.25	SLA Ti Grade 5	
	ID0850	8		
	ID1050	10		
	ID1150	11.5		
	ID1350	13		
	ID1650	16		

## Drill Sequence





BONE TYPE D-IV	BONE TYPE D-II & III	BONE TYPE D-I
1. Tri-Step* 2. 3.6	1. Tri-Step* 2. 3.6 3. (4.2)	1. Tri-Step* 2. 3.6 3. 4.2

Note: (x.xx) drill to the depth of the cortex only. All Measurements are in mm.

⚠ CAUTION: The drill preparation is up to 1mm longer than the implants.

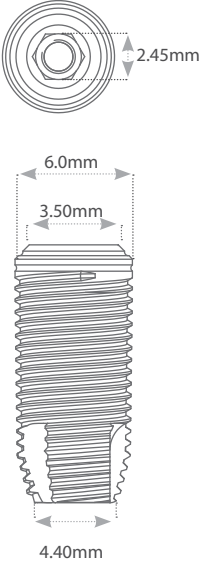
\* For initial drilling, you may use 2, 2.8 and 3.2 drills in sequence instead of the Tri-Step drill.

SWELL™ 6.0mmD

	Catalog No.	Length	Surface	
	ID0660	6.25	SLA Ti Grade 5	
	ID0860	8		
	ID1060	10		
	ID1160	11.5		
	ID1360	13		

Drill Sequence













BONE TYPE D-IV	BONE TYPE D-II & III	BONE TYPE D-I
1. Tri-Step*	1. Tri-Step*	1. Tri-Step*
2. 3.6	2. 3.6	2. 3.6
3. 4.2	3. 4.2	3. 4.2
4. (5.2)	4. 5.2	4. 5.2
	5. (5.6)	5. 5.6

Note: (x.xx) drill to the depth of the cortex only. All Measurements are in mm.









⚠ CAUTION: The drill preparation is up to 1mm longer than the implants.

\* For initial drilling, you may use 2, 2.8 and 3.2 drills in sequence instead of the Tri-Step drill.













## Healing Abutments

	RS3027	RS Slim Healing Abutment 3.5mmD x 2mmL	Ti Grade 5
	RS3028	RS Slim Healing Abutment 3.5mmD x 3mmL	Ti Grade 5
	RS3029	RS Slim Healing Abutment 3.5mmD x 4mmL	Ti Grade 5
	RS3030	RS Slim Healing Abutment 3.5mmD x 5mmL	Ti Grade 5
	RS3031	RS Slim Healing Abutment 3.5mmD x 6mmL	Ti Grade 5
	RS3022	RS Healing Abutment 4.5mmD x 2mmL	Ti Grade 5
	RS3023	RS Healing Abutment 4.5mmD x 3mmL	Ti Grade 5
	RS3024	RS Healing Abutment 4.5mmD x 4mmL	Ti Grade 5
	RS3025	RS Healing Abutment 4.5mmD x 5mmL	Ti Grade 5
	RS3026	RS Healing Abutment 4.5mmD x 6mmL	Ti Grade 5
	RS3012	RS Wide Healing Abutment 6mmD x 2mmL	Ti Grade 5
	RS3014	RS Wide Healing Abutment 6mmD x 4mmL	Ti Grade 5
	RS3015	RS Wide Healing Abutment 6mmD x 5mmL	Ti Grade 5



## Cement Retained

	RS3903	RS Slim Titanium Abutment 3mm	Ti Grade 5
	RS3906	RS Slim Titanium Abutment 6mm	Ti Grade 5
	RS3908	RS Slim Titanium Abutment 8mm	Ti Grade 5
	RS3800	RS Straight Titanium Abutment - No End Line	Ti Grade 5
	RS3801	RS Straight Titanium Abutment 1mm	Ti Grade 5
	RS3802	RS Straight Titanium Abutment 2mm	Ti Grade 5
	RS3803	RS Straight Titanium Abutment 3mm	Ti Grade 5
	RS3804	RS Straight Titanium Abutment 4mm	Ti Grade 5
	RS3811	RS Straight Titanium Abutment Long 12.5mm	Ti Grade 5

Cement Retained

	RS3090	RS Engaging Gold/Plastic Abutment	Gold/Plastic
	RS3095	RS Engaging Titanium/Plastic Abutment	Ti Grade 5/Plastic
	RS3097	RS Non Engaging Titanium/Plastic Abutment	Ti Grade 5/Plastic
	RS3411	RS Straight Cylindrical Titanium Abutment 2mm	Ti Grade 5
	RS3422	RS Straight Cylindrical Titanium Abutment 2mm w/o Hex	Ti Grade 5
	RS3812	RS One Piece Screw-in Abutment	Ti Grade 5
	RS4015	RS Angled Titanium Abutment 15°	Ti Grade 5
	RS4016	RS Angled Titanium Abutment 15° - Long	Ti Grade 5
	RS4025	RS Angled Titanium Abutment 25°	Ti Grade 5
	RS4035	RS Angled Titanium Abutment 35°	Ti Grade 5
	RS4115	RS Angled Esthetic Titanium Abutment 15° 1mm	Ti Grade 5
	RS4117	RS Angled Esthetic Titanium Abutment 15° 2mm	Ti Grade 5
	RS4119	RS Angled Esthetic Titanium Abutment 15° 3mm	Ti Grade 5
	RS5000	RS Engaging Plastic Cylinder Casting Abutment	Plastic
	RS5010	RS Engaging Plastic Casting Standard Abutment	Plastic
	RS5020	RS Non-Engaging Plastic Cylinder Casting Abutment	Plastic
	RS5030	RS Engaging Plastic Standard Abutment	Plastic
	RS5040	RS Engaging Plastic Cylinder Abutment	Plastic
	RS5050	RS Non-Engaging Plastic Standard Abutment	Plastic
	RS3890	Wide Profile Titanium Abutment	Ti Grade 5

Cement Retained Zirconium - Abutments

	ZA0005	RS Straight Zirconium Abutment w/ Titanium Base	Zirconium + Ti Grade 5
	ZA0007	RS Angled Zirconium Abutment 15° w/ Titanium Base	Zirconium + Ti Grade 5

## Screw Retained

## Trans Mucosal Abutment



RS3731

RS Straight Trans Mucosal Abutment 1mm

Ti Grade 5



RS3732

RS Straight Trans Mucosal Abutment 2mm

Ti Grade 5



RS3733

RS Straight Trans Mucosal Abutment 3mm

Ti Grade 5



RS3734

RS Angled Trans Mucosal Abutment 17° 2mm

Ti Grade 5



RS3735

RS Angled Trans Mucosal Abutment 30° 3.0mm

Ti Grade 5



RS3737

RS Angled Trans Mucosal Abutment 17° 3mm

Ti Grade 5



RS3738

RS Angled Trans Mucosal Abutment 30° 4.0mm

Ti Grade 5



RS5005

TMA Healing Cap

Ti Grade 5



RS4900

TMA Titanium Temporary Copying

Ti Grade 5



RS5001

TMA Plastic Casting Sleeve w/Prosthetic Screw

Plastic



RS5004

TMA Abutment Replica

Ti Grade 5



RS5006

TMA Impression Coping Open Tray

Ti Grade 5



RS5011

RS TMA Closed Tray Transfer

Ti Grade 5

## Flat Connection



FC4502

Flat Connection Abutment 2mm

Ti Grade 5



FC4504

Flat Connection Abutment 4mm

Ti Grade 5



FC5512

Flat Connection Temporary Cylinder Sleeve

Ti Grade 5



FC5515

Flat Connection Temporary Cylinder Sleeve

Ti Grade 5



FC5737

Flat Connection Implant Replica

Stainless Steel



FC6011

Flat Connection Castable Abutment for Centering Ring

Plastic





FC6015

Flat Connection Titanium Retaining Screw



Ti Grade 5



**Flat Connection**











	FC6013	Flat Connection Titanium Gluing Ring	Ti Grade 5
	FC6017	Flat Connection Long Laboratory Screw	Ti Grade 5
	FC6018	Flat Connection Centering Ring	Ti Grade 5

**Connection Abutment**



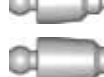

	RS3505	RS Esthetic Connection Abutment 0.5 mm	Ti Grade 5
	RS3515	RS Esthetic Connection Abutment 1.5 mm	Ti Grade 5
	RS3605	RS Connection Abutment 0.5 mm	Ti Grade 5
	RS3615	RS Connection Abutment 1.5 mm	Ti Grade 5
	RS5615	Open Tray Transfer for Connection Abutment	Ti Grade 5
	RS5100	RS Plastic Coping Connection Abutment	Plastic
	RS5715	Implant Replica for Connection Abutment	Ti Grade 5

**Overdenture**

**Ball Attachment - Overdenture**

	RS2861	RS Ball Attachment 1mm w/Hex	Ti Grade 5
	RS2862	RS Ball Attachment 2mm w/Hex	Ti Grade 5
	RS2863	RS Ball Attachment 3mm w/hex	Ti Grade 5
	RS2864	RS Ball Attachment 4mm w/Hex	Ti Grade 5
	RS2865	RS Ball Attachment 5mm w/Hex	Ti Grade 5
	RS2866	RS Ball Attachment 6mm w/Hex	Ti Grade 5
	RS2650	RS Ball Attachment 0.5 mm	Ti Grade 5
	RS2651	RS Ball Attachment 1 mm	Ti Grade 5
	RS2652	RS Ball Attachment 2 mm	Ti Grade 5
	RS2653	RS Ball Attachment 3 mm	Ti Grade 5
	RS2654	RS Ball Attachment 4 mm	Ti Grade 5
	RS2655	RS Ball Attachment 5 mm	Ti Grade 5









## Overdenture

	RS2660	Plastic Ball Cap-White	Nylon
	RS2662	Plastic Ball Cap Pink-Soft	Nylon
	RS2670	Titanium Ball Cap	Ti Grade 5
	RS2675SS	Stainless steel Ball Cap	Stainless Steel







## Prosthetic Hand Drivers

	RS6095	1.27 Hex Hand Driver-Short	Stainless Steel
	RS6094	1.27 Hex Hand Driver-Medium	Stainless Steel
	RS6097	1.27 Hex Hand Driver-Long	Stainless Steel
	RS6191	TMA/FC Female Hand Hex Driver-Long	Stainless Steel
	RS6193	TMA/FC Female Hand Hex Driver-Short	Stainless Steel



## Torque Drivers

	RS6090	Tourque Driver for Ball Attachment	Stainless Steel
	RS6011	RS 2.4 Hex Torque Driver-Short	Stainless Steel
	RS6012	RS 2.4 Hex Torque Driver-Long	Stainless Steel
	RS6197	TMA/FC Hex Torque Driver-Short	Stainless Steel
	RS6196	TMA/FC Hex Torque Driver-Long	Stainless Steel
	RS6080	1.27 Hex Torque Driver-Short	Stainless Steel
	RS6082	1.27 Hex Torque Driver-Long	Stainless Steel
	RS6025	RS One Piece Torque Driver-Short	Stainless Steel
	RS6026	RS One Piece Torque Driver-Long	Stainless Steel





### Handpiece Drivers and Adaptors

	RS9020	RS 2.4 Male Hex Hand Piece Adapter-Short	Stainless Steel
	RS9025	RS 2.4 Male Hex Hand Piece Adapter-Long	Stainless Steel
	RS9030	1.27 Hex Driver for Handpiece-Short	Stainless Steel
	RS9035	1.27 Hex Driver for Handpiece-Long	Stainless Steel
	RS6194	TMA/FC Hex Hand Piece Adapter-Short	
	RS6195	TMA/FC Hex Hand Piece Adapter-Long	

### Analog

	RS5737	RS Internal Hex Implant Analog	Stainless Steel
	RS5740	Ball Attachment Abutment Replica	Stainless Steel

### Transfers (Implant Level)

	RS5509	RS Closed Tray Transfer 9 mm	Stainless Steel
	RS5512	RS Closed Tray Transfer 12 mm	Stainless Steel
	RS5600	RS Slim Closed Tray Transfer	Stainless Steel
	RS5610	RS Open Tray Transfer	Stainless Steel

### Implant Cover Screw

	RS3435	Implant Cover Screw for Touareg™-OS Touareg™-S Swell	Ti Grade 5
---	--------	--	------------

# 52 | ONE™

## One Piece Implant System

The One™ is a tapered core spiral implant. It is as easy to use as a regular crown and bridge dentistry.





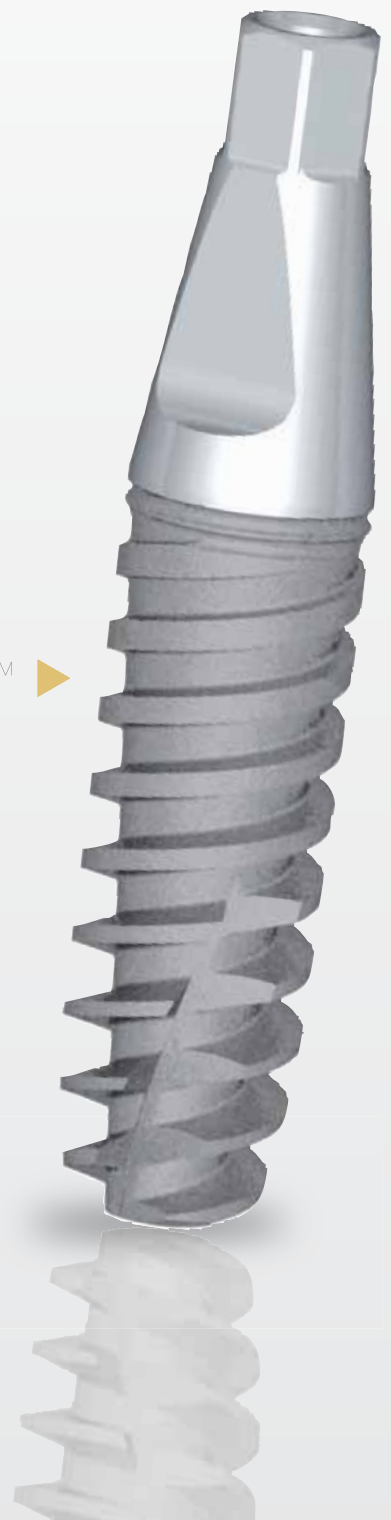

- Flexible
- Minimally invasive surgery
- Immediate Function
- Designed for narrow places
- Solves tight spacing problems
- Offers fast and easy flapless procedure
- Straight forward new drill protocol with drills for soft and hard bone
- One™ implants with narrow diameters are highly suitable replacements for laterals in the maxilla and incisors in the mandible.

ONE™ 

	L-10mm	L-11.5mm	L-13mm	L-15mm
D3.0mm	IO1030	IO1130	IO1330	IO1530
D3.3mm	IO1033	IO1133	IO1333	IO1533
D3.6mm	IO1036	IO1136	IO1336	IO1536
D4.2mm	IO1042	IO1142	IO1342	IO1542
D5.0mm	IO1050	IO1150	IO1350	IO1550



ONE™ 3.0mmD

	Catalog No.	Length	Surface	
	IO1030	10	SLA Ti Grade 5	
	IO1130	11.5		
	IO1330	13		
	IO1530	15		

Drill Sequence







BONE TYPE D-IV	BONE TYPE D-II & III	BONE TYPE D-I
1. 2.0	1. 2.0	1. 2.0 2. (2.8)

Note: (x.xx) drill to the depth of the cortex only. All Measurements are in mm.

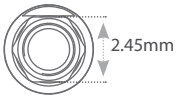
⚠ CAUTION: The drill preparation is up to 1mm longer than the implants.

\* For initial drilling, you may use 2, 2.8 and 3.2 drills in sequence instead of the Tri-Step drill.

## ONE™ 3.3mmD

	Catalog No.	Length	Surface	
	IO1033	10	SLA Ti Grade 5	
	IO1133	11.5		
	IO1333	13		
	IO1533	15		

## Drill Sequence







BONE TYPE D-IV	BONE TYPE D-II & III	BONE TYPE D-I
1. 2.0	1. 2.0 2. (2.8)	1. 2.0 2. 2.8

Note: (x.xx) drill to the depth of the cortex only. All Measurements are in mm.

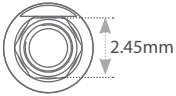
⚠ CAUTION: The drill preparation is up to 1mm longer than the implants.

\* For initial drilling, you may use 2, 2.8 and 3.2 drills in sequence instead of the Tri-Step drill.

ONE™ 3.6mmD

	Catalog No.	Length	Surface	
	IO1036	10	SLA Ti Grade 5	
	IO1136	11.5		
	IO1336	13		
	IO1536	15		

Drill Sequence







BONE TYPE D-IV	BONE TYPE D-II & III	BONE TYPE D-I
1. Tri-Step*	1. Tri-Step*	1. Tri-Step*

Note: (x.xx) drill to the depth of the cortex only. All Measurements are in mm.

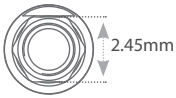
⚠ CAUTION: The drill preparation is up to 1mm longer than the implants.

\* For initial drilling, you may use 2, 2.8 and 3.2 drills in sequence instead of the Tri-Step drill.

## ONE™ 3.3mmD

	Catalog No.	Length	Surface	
	IO1033	10	SLA Ti Grade 5	
	IO1133	11.5		
	IO1333	13		
	IO1533	15		

## Drill Sequence

BONE TYPE D-IV	BONE TYPE D-II & III	BONE TYPE D-I
1. 2.0	1. 2.0 2. (2.8)	1. 2.0 2. 2.8







Note: (x.xx) drill to the depth of the cortex only. All Measurements are in mm.

⚠ CAUTION: The drill preparation is up to 1mm longer than the implants.

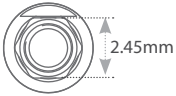
\* For initial drilling, you may use 2, 2.8 and 3.2 drills in sequence instead of the Tri-Step drill.



ONE™ 3.6mmD

	Catalog No.	Length	Surface	
	IO1036	10	SLA Ti Grade 5	
	IO1136	11.5		
	IO1336	13		
	IO1536	15		

Drill Sequence

BONE TYPE D-IV	BONE TYPE D-II & III	BONE TYPE D-I
1. Tri-Step*	1. Tri-Step*	1. Tri-Step*

Note: (x.xx) drill to the depth of the cortex only. All Measurements are in mm.

⚠ CAUTION: The drill preparation is up to 1mm longer than the implants.

\* For initial drilling, you may use 2, 2.8 and 3.2 drills in sequence instead of the Tri-Step drill.

# 58 KITS



Touareg CloseFit™ Surgical Kit

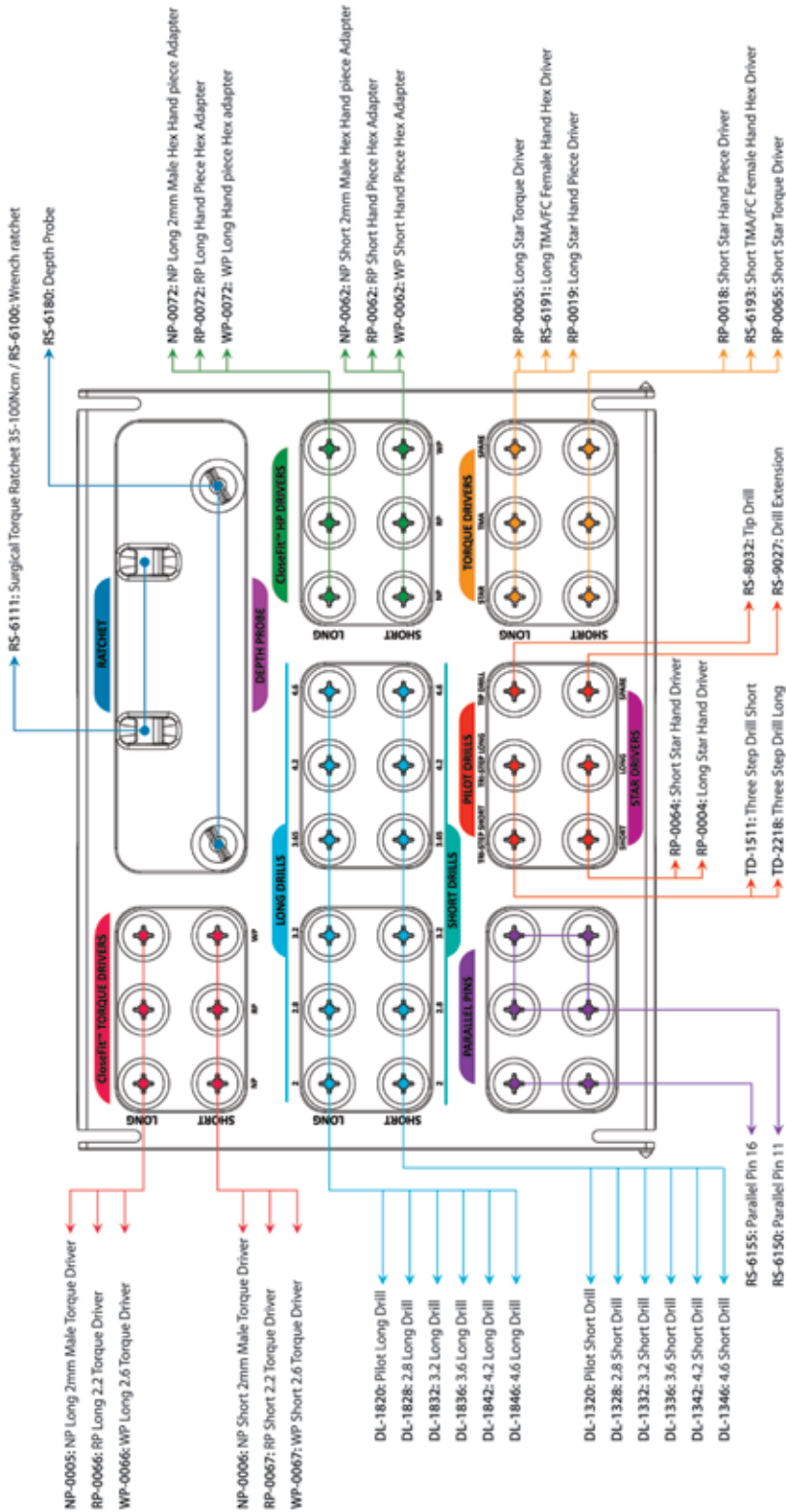

## CF6300: Toureg CloseFit™ Plastic Surgical Kit - Premium

RS6111	Surgical torque ratchet 35-100Ncm	DL1828	Twist Step Drill 2.3/2.8mmD x 8-18mmL
RS6180	Depth probe	DL1832	Twist Step Drill 2.8/3.2mmD x 8-18mmL
NP0005	NP 2mm Hex Torque Driver-Long	DL1836	Twist Step Drill 3.2/3.6mmD x 8-18mmL
NP0006	NP 2mm Hex Torque Driver-Short	DL1842	Twist Step Drill 3.8/4.2mmD x 8-18mmL
RP0066	RP 2.2mm Hex Torque Driver-Long	DL1846	Twist Step Drill 4.2/4.6mmD x 8-18mmL
RP0067	RP 2.2mm Hex Torque Driver-Short	TD1511	Three Step Drill-Short
WP0067	WP 2.6mm Hex Torque Driver-Short	TD2218	Three Step Drill-Long
WP0066	WP 2.6mm Hex Torque Driver-Long	RS8032	Tip Drill
NP0062	NP 2mm Hex Handpiece Adapter-Short	RS9027	Drill Extension
NP0072	NP 2mm Hex Handpiece Adapter-Long	RP0005	Star Torque Driver-Long
RP0062	RP Handpiece Hex Adapter-short	RP0065	Star Torque Driver-Short
RP0072	RP Handpiece Hex Adapter-Long	RP0064	Star Hand Driver-Short
WP0062	WP Handpiece Hex Adapter-Short	RP0004	Star Hand Driver-Long
WP0072	WP Handpiece Hex Adapter-Long	RP0018	Star Handpiece Driver-Short
RS6150	Parallel Pin 11 (4 Pieces)	RP0019	Star Handpiece Driver-Long
RS6155	Parallel Pin 16 (2 Pieces)	RS6191	TMA/FC Female Hand Hex Driver-Long
DL1820	Pilot Drill 2mmD x 8-18mmL	RS6193	TMA/FC Female Hand Hex Driver-Short
		CF6301	Toureg CloseFit™ Surgical Tray

## CF6302: Toureg CloseFit™ Plastic Surgical Kit - Advanced

RS6180	Depth probe	DL1820	Pilot Drill 2mmD x 8-18mmL
RS9027	Drill extension	DL1828	Twist Step Drill 2.3/2.8mmD x 8-18mmL
NP0005	NP 2mm Hex Torque Driver-Long	DL1832	Twist Step Drill 2.8/3.2mmD x 8-18mmL
NP0006	NP 2mm Hex Torque Driver-Short	DL1836	Twist Step Drill 3.2/3.6mmD x 8-18mmL
RS6150	Parallel Pin 11 (4 Pieces)	DL1842	Twist Step Drill 3.8/4.2mmD x 8-18mmL
RS6155	Parallel Pin 16 (2 Pieces)	DL1846	Twist Step Drill 4.2/4.6mmD x 8-18mmL
RP0067	RP 2.2mm Hex Torque Driver-Short	WP0066	WP 2.6mm Hex Torque Driver-Long
RP0066	RP 2.2mm Hex Torque Driver-Long	WP0067	WP 2.6mm Hex Torque Driver-Short
RP0004	Star Hand Driver-Long	RP0019	Star Handpiece Driver-Long
RP0064	Star Hand Driver-Short	RP0018	Star Handpiece Driver-Short
RS6111	Surgical torque ratchet 35-100 Ncm	CF6301	Toureg CloseFit™ Surgical Tray

## CF6303: Toureg CloseFit™ Plastic Surgical Kit - Starter

NP0005	NP 2mm Hex Torque Driver-Long	DL1820	Pilot Drill 2mmD x 8-18mmL
NP0006	NP 2mm Hex Torque Driver-Short	DL1828	Twist Step Drill 2.3/2.8mmD x 8-18mmL
RP0067	RP 2.2mm Hex Torque Driver-Short	DL1832	Twist Step Drill 2.8/3.2mmD x 8-18mmL
RP0066	RP 2.2mm Hex Torque Driver-Long	DL1836	Twist Step Drill 3.2/3.6mmD x 8-18mmL
RP0004	Star Hand Driver-Long	RP0019	Star Handpiece Driver-Long
RP0064	Star Hand Driver-Short	RP0018	Star Handpiece Driver-Short
WP0066	WP 2.6mm Hex Torque Driver-Long	RS6100	Wrench Ratchet
WP0067	WP 2.6mm Hex Torque Driver-Short	CF6301	Toureg CloseFit™ Surgical Tray

Touareg™ RS - Standard Internal Hex Surgical Kit

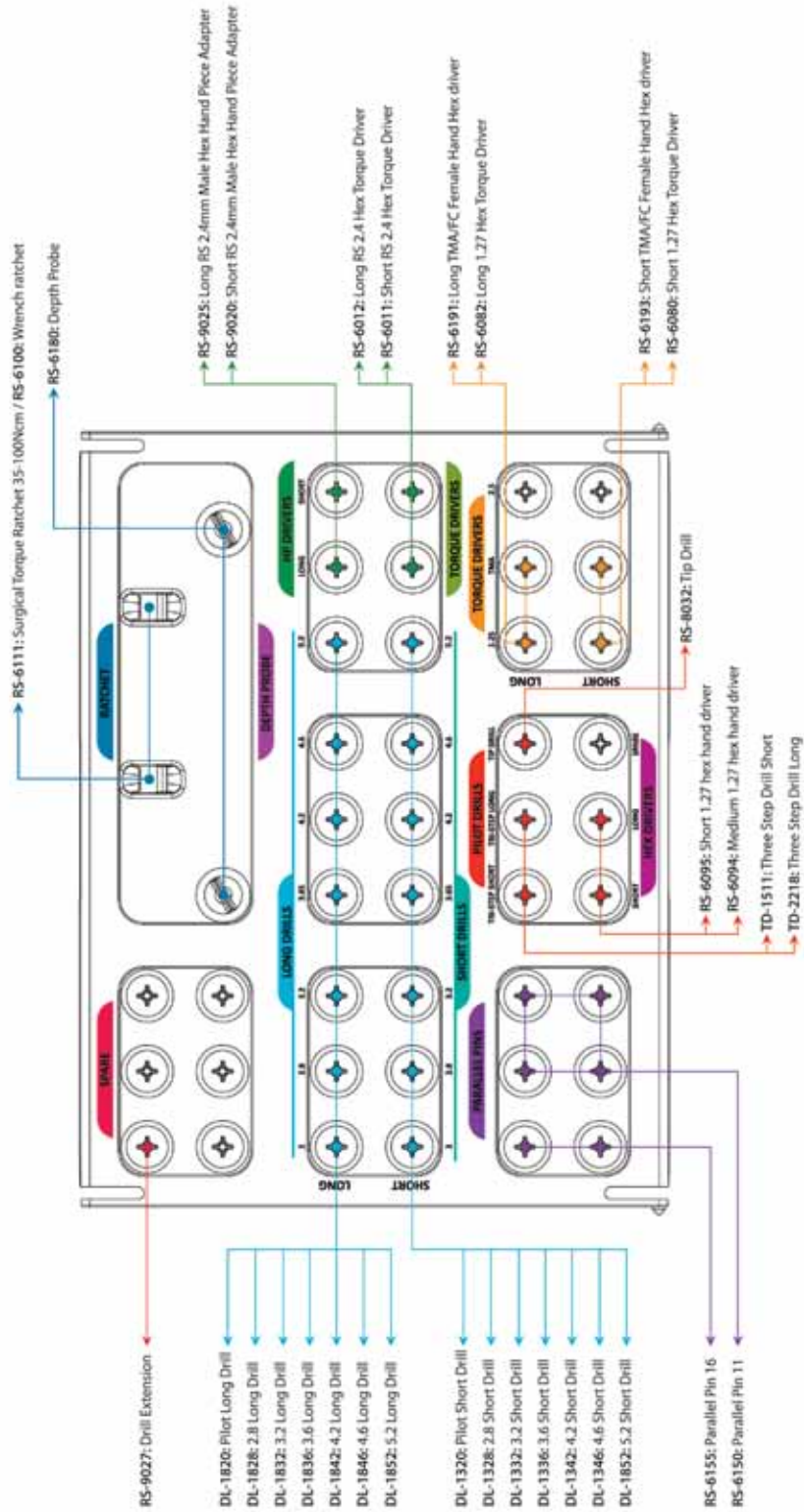

## RS6301: RS - Standard Internal Hex Plastic Surgical Kit - Premium

RS6111	Surgical torque ratchet 35-100Ncm	RS6011	RS 2.4 Hex Torque Driver-Short
RS6180	Depth probe	RS6012	RS 2.4 Hex Torque Driver-Long
DL1820	Pilot Drill 2mmD x 8-18mmL	RS6150	Parallel Pin 11 (4 Pieces)
DL1828	Twist Step Drill 2.3/2.8mmD x 8-18mmL	RS6155	Parallel Pin 16 (2 Pieces)
DL1832	Twist Step Drill 2.8/3.2mmD x 8-18mmL	RS8032	Tip Drill
DL1836	Twist Step Drill 3.2/3.6mmD x 8-18mmL	RS9027	Drill Extension
DL1842	Twist Step Drill 3.8/4.2mmD x 8-18mmL	RS6094	1.27 Hex Hand Driver-Medium
DL1846	Twist Step Drill 4.2/4.6mmD x 8-18mmL	RS6095	1.27 Hex Hand Driver-Short
DL1852	Twist Step Drill 4.8/5.2mmD x 8-18mmL	RS6191	TMA/FC Female Hand Hex Driver-Long
TD1511	Three Step Drill-Short	RS6193	TMA/FC Female Hand Hex Driver-Short
TD2218	Three Step Drill-Long	RS6082	1.27 Hex Torque Driver-Long
RS9020	RS 2.4mm Hex Handpiece Adapter-Short	RS6080	1.27 Hex Torque Driver-Short
RS9025	RS 2.4mm Hex Handpiece Adapter-Long	RS6312	Surgery Kit Standard Hex - Plastic Tray

## RS6322: RS - Standard Internal Hex Plastic Surgical Kit - Advanced

DL1820	Pilot Drill 2mmD x 8-18mmL	RS6150	Parallel Pin 11 (4 pieces)
DL1828	Twist Step Drill 2.3/2.8mmD x 8-18mmL	RS6155	Parallel Pin 16 (2 pieces)
DL1832	Twist Step Drill 2.8/3.2mmD x 8-18mmL	RS6180	Depth probe
DL1836	Twist Step Drill 3.2/3.6mmD x 8-18mmL	RS9027	Drill extension
DL1842	Twist Step Drill 3.8/4.2mmD x 8-18mmL	RS6094	1.27 Hex Hand Driver-Medium
DL1846	Twist Step Drill 4.2/4.6mmD x 8-18mmL	RS6095	1.27 Hex Hand Driver-Short
RS6111	Surgical torque ratchet 35-100 Ncm	RS6080	1.27 Hex Torque Driver-Short
RS6011	RS 2.4 Hex Torque Driver-Short	RS6082	1.27 Hex Torque Driver-Long
RS6012	RS 2.4 Hex Torque Driver-Long	RS6312	Surgical Kit Standard Hex - Plastic Tray

## RS6333: RS - Standard Internal Hex Plastic Surgical Kit - Starter

DL1820	Pilot Drill 2mmD x 8-18mmL	RS6082	1.27 Hex Torque Driver-Long
DL1828	Twist Step Drill 2.3/2.8mmD x 8-18mmL	RS6011	RS 2.4 Hex Torque Driver-Short
DL1832	Twist Step Drill 2.8/3.2mmD x 8-18mmL	RS6012	RS 2.4 Hex Torque Driver-Long
DL1836	Twist Step Drill 3.2/3.6mmD x 8-18mmL	RS6100	Wrench Ratchet
DL1842	Twist Step Drill 3.8/4.2mmD x 8-18mmL	RS6094	1.27 Hex Hand Driver-Medium
DL1846	Twist Step Drill 4.2/4.6mmD x 8-18mmL	RS6095	1.27 Hex Hand Driver-Short
RS6080	1.27 Hex Torque Driver-Short	RS6312	Surgical Kit Standard Hex - Plastic Tray

## PK6300: Prosthetic Kit

RS6112	Prosthetic Torque Ratchet 15-35Ncm	RS6195	TMA/FC Hex Handpiece adapter-Long
RS6095	1.27 Hex Hand Driver-Short	RP0005	Star Torque Driver-Long
RS6094	1.27 Hex Hand Driver-Medium	RP0065	Star Torque Driver-Short
RS6080	1.27 Hex Torque Driver-Short	RP0019	Star Handpiece Driver-Long
RS6082	1.27 Hex Torque Driver-Long	RP0018	Star Handpiece Driver-Short
RS9030	1.27 Hex Driver for Handpiece-Short	RP0004	Star Hand Driver-Long
RS9035	1.27 Hex Driver for Handpiece-Long	RP0064	Star Hand Driver- Short
RS6191	TMA/FC Female Hand Hex Driver-Long	RS6090	Torque Driver for Ball Attachment
RS6193	TMA/FC Female Hand Hex Driver-Short	NP0014	NP Retrieval Screw for Abutments
RS6197	TMA/FC Hex Torque Driver-Short	RP3401	RP Retrieval Screw for Abutments
RS6196	TMA/FC Hex Torque Driver-Long	WP3401	WP Retrieval Screw for Abutments
RS6194	TMA/FC Hex Handpiece adapter-Short	RS3401	RS Retrieval Screw for Abutments
		PK6303	Prosthetic Kit Tray



Long DLC Two Step Drills

	DL1820	Pilot Drill 2mmD x 8-18mmL White	White	Stainless Steel & DLC
	DL1828	Twist Step Drill 2.3/2.8mmD x 8-18mmL	Red	Stainless Steel & DLC
	DL1832	Twist Step Drill 2.8/3.2mmD x 8-18mmL	Blue	Stainless Steel & DLC
	DL1836	Twist Step Drill 3.2/3.6mmD x 8-18mmL	Green	Stainless Steel & DLC
	DL1842	Twist Step Drill 3.8/4.2mmD x 8-18mmL	Black	Stainless Steel & DLC
	DL1846	Twist Step Drill 4.2/4.6mmD x 8-18mmL	Yellow	Stainless Steel & DLC
	DL1852	Twist Step Drill 4.8/5.2mmD x 8-18mmL	Brown	Stainless Steel & DLC
	DL1856	Twist Step Drill 5.2/5.6mmD x 8-18mmL	Grey	Stainless Steel & DLC

Short DLC Two Step Drills

	DL1320	Pilot Drill 2mmD x 3-13mmL	White	Stainless Steel & DLC
	DL1328	Twist Step Drill 2.3/2.8mmD x 6-13mmL	Red	Stainless Steel & DLC
	DL1332	Twist Step Drill 2.8/3.2mmD x 6-13mmL	Blue	Stainless Steel & DLC
	DL1336	Twist Step Drill 3.2/3.6mmD x 6-13mmL	Green	Stainless Steel & DLC
	DL1342	Twist Step Drill 3.8/4.2mmD x 6-13mmL	Black	Stainless Steel & DLC
	DL1346	Twist Step Drill 4.2/4.6mmD x 6-13mmL	Yellow	Stainless Steel & DLC
	DL1352	Twist Step Drill 4.8/5.2mmD x 6-13mmL	Brown	Stainless Steel & DLC
	DL1356	Twist Step Drill 5.2/5.6mmD x 6-13mmL	Grey	Stainless Steel & DLC

Three Step DLC Drills

	TD1511	Three Step Drill-Short	Stainless Steel
	TD2218	Three Step Drill-Long	Stainless Steel

Tip Drill

	RS8032	Tip Drill Stainless Steel	Stainless Steel
---	--------	---------------------------	-----------------

## Surgical Tools

RS6111



Surgical Torque Ratchet 35-100 Ncm | Ti Grade 5

RS6112



Prosthetic Torque Ratchet 15-35Ncm | Ti Grade 5

RS6100



wrench ratchet | Ti Grade 5

RS7001



Surgical Driver | Ti Grade 5

RS6180



Depth probe | Ti Grade 5

## Osteotomes

HA0074



OSTEOTOME HANDLE | Aluminium + Stainless Steel

HA0061



Osteotome Insert 2.0mmD | Ti Grade 5

HA0064



Osteotome Insert 2.8mmD | Ti Grade 5

HA0067



Osteotome Insert 3.25mmD | Ti Grade 5

HA0070







Osteotome Insert 3.65mmD | Ti Grade 5

HA1000

OSTEOTOME KIT | Ti Grade 5





Surgical Tools

	RS9020	RS 2.4 Male Hex Hand Piece Adapter-Short	Stainless Steel
	RS9025	RS 2.4 Male Hex Hand Piece Adapter-Long	Stainless Steel
	RS9027	Drill Extension	stainless steel
	RS6150	Parallel Pin 11	stainless steel
	RS6155	Parallel Pin 16	stainless steel

Surgical Tools

	NP0005	NP 2mm Male Torque Driver-Long	Stainless Steel
	NP0006	NP 2mm Male Torque Driver-Short	Stainless Steel
	RP0066	RP 2.2 Torque Driver-Long	Stainless Steel
	RP0067	RP 2.2 Torque Driver-Short	Stainless Steel
	WP0066	WP 2.6 Torque Driver-Long	Stainless Steel
	WP0067	WP 2.6 Torque Driver-Short	Stainless Steel
	RS6011	RS 2.4 Hex Torque Driver-Short	Stainless Steel
	RS6012	RS 2.4 Hex Torque Driver-Long	Stainless Steel
	RS6094	1.27 Hex Hand Driver-Medium	Ti Grade 5
	RS6095	1.27 Hex Hand Driver-Short	Ti Grade 5
	RS6191	TMA/FC Female Hand Hex Driver-Long	Ti Grade 5
	RS6193	TMA/FC Female Hand Hex Driver-Short	Ti Grade 5

Implant Removal Tools

	RS9040	Screw Type RS/WP Implant Removal Tool	Ti Grade 5
	RS9041	Screw Type NP/RP Implant Removal Tool	Ti Grade 5



The objective way to measure implant stability

Catalog No.	Description	Page No.	Catalog No.	Description	Page No.
CF6300	Touareg CloseFit™ Plastic Surgical Kit - Premium	60	ID1650	Swell™ Dental Implant 5.0D 16L	40,44
CF6302	Touareg CloseFit™ Plastic Surgical Kit - Advanced	60	ID1833	Swell™ Dental Implant 3.3D 18L	40,41
CF6303	Touareg CloseFit™ Plastic Surgical Kit - Starter	60	ID1838	Swell™ Dental Implant 3.75D 18L	40,42
DL1320	Pilot Drill 2mmD x 6-13mmL	63	ID1842	Swell™ Dental Implant 4.2D 18L	40,43
DL1328	Twist Step Drill 2.3/2.8mmD x 6-13mmL	63	IO1030	One™ Dental Implant 3.0D 10L	52,53
DL1332	Twist Step Drill 2.8/3.2mmD x 6-13mmL	63	IO1033	One™ Dental Implant 3.3D 10L	52,54
DL1336	Twist Step Drill 3.2/3.6mmD x 6-13mmL	63	IO1036	One™ Dental Implant 3.6D 10L	52,55
DL1342	Twist Step Drill 3.8/4.2mmD x 6-13mmL	63	IO1042	One™ Dental Implant 4.2D 10L	52,56
DL1346	Twist Step Drill 4.2/4.6mmD x 6-13mmL	63	IO1050	One™ Dental Implant 5.0D 10L	52,57
DL1352	Twist Step Drill 4.8/5.2mmD x 6-13mmL	63	IO1130	One™ Dental Implant 3.0D 11.5L	52,53
DL1356	Twist Step Drill 5.2/5.6mmD x 6-13mmL	63	IO1133	One™ Dental Implant 3.3D 11.5L	52,54
DL1820	Pilot Drill 2mmD x 8-18mmL	63	IO1136	One™ Dental Implant 3.6D 11.5L	52,55
DL1828	Twist Step Drill 2.3/2.8mmD x 8-18mmL	63	IO1142	One™ Dental Implant 4.2D 11.5L	52,56
DL1832	Twist Step Drill 2.8/3.2mmD x 8-18mmL	63	IO1150	One™ Dental Implant 5.0D 11.5L	52,57
DL1836	Twist Step Drill 3.2/3.6mmD x 8-18mmL	63	IO1330	One™ Dental Implant 3.0D 13L	52,53
DL1842	Twist Step Drill 3.8/4.2mmD x 8-18mmL	63	IO1333	One™ Dental Implant 3.3D 13L	52,54
DL1846	Twist Step Drill 4.2/4.6mmD x 8-18mmL	63	IO1336	One™ Dental Implant 3.6D 13L	52,55
DL1852	Twist Step Drill 4.8/5.2mmD x 8-18mmL	63	IO1342	One™ Dental Implant 4.2D 13L	52,56
DL1856	Twist Step Drill 5.2/5.6mmD x 8-18mmL	63	IO1350	One™ Dental Implant 5.0D 13L	52,57
FC4502	Flat Connection Abutment 2mm	48	IO1530	One™ Dental Implant 3.0D 15L	52,53
FC4504	Flat Connection Abutment 4mm	48	IO1533	One™ Dental Implant 3.3D 15L	52,54
FC5512	Flat Connection Transfer Impression Coping	13,19,26,48	IO1536	One™ Dental Implant 3.6D 15L	52,55
FC5515	Flat Connection Temporary Cylinder Sleeve	12,18,25,48	IO1542	One™ Dental Implant 4.2D 15L	52,56
FC5737	Flat Connection Implant Replica	12,18,25,48	IO1550	One™ Dental Implant 5.0D 15L	52,57
FC6011	Flat Connection Castable Abutment for Centering Ring	12,19,25,48	ISF0642	Touareg™-OS Dental Implant 4.2D 6.25L	28,32
FC6013	Flat Connection Titanium Gluing Ring	13,19,25,49	ISF0650	Touareg™-OS Dental Implant 5.0D 6.25L	28,33
FC6015	Flat Connection Titanium Retaining Screw	13,19,25,48	ISF0660	Touareg™-OS Dental Implant 6.0D 6.25L	28,34
FC6017	Flat Connection Long Laboratory Screw	13,19,26,49	ISF0838	Touareg™-OS Dental Implant 3.75D 8L	28,31
FC6018	Flat Connection Centering Ring	13,19,26,49	ISF0842	Touareg™-OS Dental Implant 4.2D 8L	28,32
HA0062	Osteotome Insert 2.0mmD	64	ISF0850	Touareg™-OS Dental Implant 5.0D 8L	28,33
HA0065	Osteotome Insert 2.8mmD	64	ISF0860	Touareg™-OS Dental Implant 6.0D 8L	28,34
HA0068	Osteotome Insert 3.25mmD	64	ISF1035	Touareg™-OS Dental Implant 3.5D 10L	28,30
HA0071	Osteotome Insert 3.65mmD	64	ISF1038	Touareg™-OS Dental Implant 3.75D 10L	28,31
HA0074	Osteotome Handle	64	ISF1042	Touareg™-OS Dental Implant 4.2D 10L	28,32
HA1000	Osteotome Kit	64	ISF1050	Touareg™-OS Dental Implant 5.0D 10L	28,33
ID0642	Swell™ Dental Implant 4.2D 6.25L	40,43	ISF1060	Touareg™-OS Dental Implant 6.0D 10L	28,34
ID0650	Swell™ Dental Implant 5.0D 6.25L	40,44	ISF1135	Touareg™-OS Dental Implant 3.5D 11.5L	28,30
ID0660	Swell™ Dental Implant 6.0D 6.25L	40,45	ISF1138	Touareg™-OS Dental Implant 3.75D 11.5L	28,31
ID0838	Swell™ Dental Implant 3.75D 8L	40,42	ISF1142	Touareg™-OS Dental Implant 4.2D 11.5L	28,32
ID0842	Swell™ Dental Implant 4.2D 8L	40,43	ISF1150	Touareg™-OS Dental Implant 5.0D 11.5L	28,33
ID0850	Swell™ Dental Implant 5.0D 8L	40,44	ISF1160	Touareg™-OS Dental Implant 6.0D 11.5L	28,34
ID0860	Swell™ Dental Implant 6.0D 8L	40,45	ISF1335	Touareg™-OS Dental Implant 3.5D 13L	28,30
ID1033	Swell™ Dental Implant 3.3D 10L	40,41	ISF1338	Touareg™-OS Dental Implant 3.75D 13L	28,31
ID1038	Swell™ Dental Implant 3.75D 10L	40,42	ISF1342	Touareg™-OS Dental Implant 4.2D 13L	28,32
ID1042	Swell™ Dental Implant 4.2D 10L	40,43	ISF1350	Touareg™-OS Dental Implant 5.0D 13L	28,33
ID1050	Swell™ Dental Implant 5.0D 10L	40,44	ISF1360	Touareg™-OS Dental Implant 6.0D 13L	28,34
ID1060	Swell™ Dental Implant 6.0D 10L	40,45	ISF1635	Touareg™-OS Dental Implant 3.5D 16L	28,30
ID1133	Swell™ Dental Implant 3.3D 11.5L	40,41	ISF1638	Touareg™-OS Dental Implant 3.75D 16L	28,31
ID1138	Swell™ Dental Implant 3.75D 11.5L	40,42	ISF1642	Touareg™-OS Dental Implant 4.2D 16L	28,32
ID1142	Swell™ Dental Implant 4.2D 11.5L	40,43	ISF1650	Touareg™-OS Dental Implant 5.0D 16L	28,33
ID1150	Swell™ Dental Implant 5.0D 11.5L	40,44	ISF1835	Touareg™-OS Dental Implant 3.5D 18L	28,30
ID1160	Swell™ Dental Implant 6.0D 11.5L	40,45	ISF1838	Touareg™-OS Dental Implant 3.75D 18L	28,31
ID1333	Swell™ Dental Implant 3.3D 13L	40,41	ISF1842	Touareg™-OS Dental Implant 4.2D 18L	28,32
ID1338	Swell™ Dental Implant 3.75D 13L	40,42	ISPNP1030	Touareg™ CloseFit™ NP Dental Implant 3.0D 10L	8,10
ID1342	Swell™ Dental Implant 4.2D 13L	40,43	ISPNP1130	Touareg™ CloseFit™ NP Dental Implant 3.0D 11.5L	8,10
ID1350	Swell™ Dental Implant 5.0D 13L	40,44	ISPNP1330	Touareg™ CloseFit™ NP Dental Implant 3.0D 13L	8,10
ID1360	Swell™ Dental Implant 6.0D 13L	40,45	ISPNP1630	Touareg™ CloseFit™ NP Dental Implant 3.0D 16L	8,10
ID1633	Swell™ Dental Implant 3.3D 16L	40,41	ISPNP1830	Touareg™ CloseFit™ NP Dental Implant 3.0D 18L	8,10
ID1638	Swell™ Dental Implant 3.75D 16L	40,42	ISPS0642	Touareg™-S Dental Implant 4.2D 6.25L	28,37
ID1642	Swell™ Dental Implant 4.2D 16L	40,43	ISPS0650	Touareg™-S Dental Implant 5.0D 6.25L	28,38

Catalog No.	Description	Page No.	Catalog No.	Description	Page No.
ISPS0660	Touareg™-S Dental Implant 6.0D 6.25L	28,39	NP0018	NP Angled Abutment 15° - No End Line	11
ISPS0838	Touareg™-S Dental Implant 3.75D 8L	28,36	NP0019	NP Straight Abutment 1mm	11
ISPS0842	Touareg™-S Dental Implant 4.2D 8L	28,37	NP0020	NP Ball Attachment 0.5mm	13
ISPS0850	Touareg™-S Dental Implant 5.0D 8L	28,38	NP0021	NP Ball Attachment 1mm	13
ISPS0860	Touareg™-S Dental Implant 6.0D 8L	28,39	NP0022	NP Ball Attachment 2mm	13
ISPS1035	Touareg™-S Dental Implant 3.5D 10L	28,35	NP0023	NP Ball Attachment 3mm	13
ISPS1038	Touareg™-S Dental Implant 3.75D 10L	28,36	NP0024	NP Ball Attachment 4mm	13
ISPS1042	Touareg™-S Dental Implant 4.2D 10L	28,37	NP0026	NP Angled Abutment 15° 2mm	11
ISPS1050	Touareg™-S Dental Implant 5.0D 10L	28,38	NP0030	NP Flat Connection Abutment 2mm	12
ISPS1060	Touareg™-S Dental Implant 6.0D 10L	28,39	NP0031	NP Flat Connection Abutment 4mm	12
ISPS1135	Touareg™-S Dental Implant 3.5D 11.5L	28,35	NP0032	NP Straight Trans Mucosal Abutment 1mm	12
ISPS1138	Touareg™-S Dental Implant 3.75D 11.5L	28,36	NP0033	NP Straight Trans Mucosal Abutment 2mm	12
ISPS1142	Touareg™-S Dental Implant 4.2D 11.5L	28,37	NP0034	NP Straight Trans Mucosal Abutment 3mm	12
ISPS1150	Touareg™-S Dental Implant 5.0D 11.5L	28,38	NP0035	NP Angled Trans Mucosal Abutment 17° 3mmL	12
ISPS1160	Touareg™-S Dental Implant 6.0D 11.5L	28,39	NP0036	NP Angled Trans Mucosal Abutment 30° 3.5mmL	12
ISPS1335	Touareg™-S Dental Implant 3.5D 13L	28,35	NP0037	NP Angled Trans Mucosal Abutment 30° 2.5mmL	12
ISPS1338	Touareg™-S Dental Implant 3.75D 13L	28,36	NP0038	NP Angled Trans Mucosal Abutment 17° 4mmL	12
ISPS1342	Touareg™-S Dental Implant 4.2D 13L	28,37	NP0043	NP Engaging Temporary Abutment	11
ISPS1350	Touareg™-S Dental Implant 5.0D 13L	28,38	NP0044	NP Non-Engaging Temporary Abutment	11
ISPS1360	Touareg™-S Dental Implant 6.0D 13L	28,39	NP0045	NP Plastic Cylinder Abutment	11
ISPS1635	Touareg™-S Dental Implant 3.5D 16L	28,35	NP0046	NP Slim Healing Abutment 3mmD x 2mmL	11
ISPS1638	Touareg™-S Dental Implant 3.75D 16L	28,36	NP0047	NP Slim Healing Abutment 3mmD x 3mmL	11
ISPS1642	Touareg™-S Dental Implant 4.2D 16L	28,37	NP0048	NP Slim Healing Abutment 3mmD x 4mmL	11
ISPS1650	Touareg™-S Dental Implant 5.0D 16L	28,38	NP0049	NP Slim Healing Abutment 3mmD x 5mmL	11
ISPS1835	Touareg™-S Dental Implant 3.5D 18L	28,35	NP0050	NP Slim Healing Abutment 3mmD x 6mmL	11
ISPS1838	Touareg™-S Dental Implant 3.75D 18L	28,36	NP0062	NP 2mm Hex Handpiece Adapter-Short	14
ISPS1842	Touareg™-S Dental Implant 4.2D 18L	28,37	NP0063	NP Angled Abutment 15° 3mm	11
ISPX0835	Touareg CloseFit™ RP Dental Implant 3.5D 8L	8,16	NP0064	NP Straight Abutment 3mm	11
ISPX0843	Touareg CloseFit™ WP Dental Implant 4.3D 8.0L	8,32	NP0072	NP 2mm Hex Handpiece Adapter-Long	14
ISPX0849	Touareg CloseFit™ WP Dental Implant 5.0D 8.0L	8,33	NP0090	NP Conical Healing Abutment 4.5mmD x 2mmL	11
ISPX1035	Touareg CloseFit™ RP Dental Implant 3.5D 10L	8,16	NP0091	NP Conical Healing Abutment 4.5mmD x 3mmL	11
ISPX1043	Touareg CloseFit™ WP Dental Implant 4.3D 10L	8,32	NP0092	NP Conical Healing Abutment 4.5mmD x 4mmL	11
ISPX1049	Touareg CloseFit™ WP Dental Implant 5.0D 10L	8,33	NP0093	NP Conical Healing Abutment 4.5mmD x 5mmL	11
ISPX1135	Touareg CloseFit™ RP Dental Implant 3.5D 11.5L	8,16	NP0094	NP Conical Healing Abutment 4.5mmD x 6mmL	11
ISPX1143	Touareg CloseFit™ WP Dental Implant 4.3D 11.5L	8,32	NP3095	NP Engaging Titanium/Plastic Abutment	12
ISPX1149	Touareg CloseFit™ WP Dental Implant 5.0D 11.5L	8,33	NP3097	NP Non-Engaging Titanium/Plastic Abutment	12
ISPX1335	Touareg CloseFit™ RP Dental Implant 3.5D 13L	8,16	PK6300	Prosthetic Kit Metal	62
ISPX1343	Touareg CloseFit™ WP Dental Implant 4.3D 13L	8,32	RP0001	RP Abutment Screw	18
ISPX1349	Touareg CloseFit™ WP Dental Implant 5.0D 13L	8,33	RP0004	Star Hand Driver-Long	13,20,26,60,62
ISPX1535	Touareg CloseFit™ RP Dental Implant 3.5D 15L	8,16	RP0005	Star Torque Driver-Long	13,20,27,60,62
ISPX1543	Touareg CloseFit™ WP Dental Implant 4.3D 15L	8,32	RP0007	RP Implant Analog	21
ISPX1549	Touareg CloseFit™ WP Dental Implant 5.0D 15L	8,33	RP0010	RP Straight Abutment 3mm	17
ISPX1835	Touareg CloseFit™ RP Dental Implant 3.5D 18L	8,16	RP0011	RP Straight Abutment 2mm	17
ISPX1843	Touareg CloseFit™ WP Dental Implant 4.3D 18L	8,32	RP0012	RP Straight Abutment 1mm	17
ISPX1849	Touareg CloseFit™ WP Dental Implant 5.0D 18L	8,33	RP0013	RP Angled Abutment 15° 1mm	17
NP0001	NP Abutment Screw	12	RP0014	RP Angled Abutment 15° 2mm	17
NP0004	NP Healing Abutment 4.5mmD x 2mmL	11	RP0015	RP Angled Abutment 15° 3mm	17
NP0005	NP 2mm Hex Torque Driver-Long	13	RP0016	RP Slim Closed Tray Transfer	21
NP0006	NP 2mm Hex Torque Driver-Short	13	RP0017	RP Open Tray Transfer	21
NP0007	NP Implant Analog	14	RP0018	Star Handpiece Driver-Short	27
NP0008	NP Healing Abutment 4.5mmD x 3mmL	11	RP0019	Star Handpiece Driver-Long	27
NP0009	NP Healing Abutment 4.5mmD x 4mmL	11	RP0020	RP Straight Slim Abutment - No End Line	17
NP0010	NP Straight Slim Abutment - No End Line	11	RP0022	RP Healing Abutment 4.5mmD x 2mmL	17
NP0011	NP Straight Abutment 2mm	11	RP0023	RP Healing Abutment 4.5mmD x 3mmL	17
NP0012	NP Healing Abutment 4.5mmD x 5mmL	11	RP0024	RP Healing Abutment 4.5mmD x 4mmL	17
NP0013	NP Healing Abutment 4.5mmD x 6mmL	11	RP0025	RP Healing Abutment 4.5mmD x 5mmL	17
NP0014	NP Retrieval Screw for Abutments	14,62	RP0026	RP Healing Abutment 4.5mmD x 6mmL	17
NP0015	NP Angled Abutment 15° 1mm	11	RP0030	RP Flat Connection Abutment 2mm	18
NP0016	NP Slim Closed Tray Transfer	14	RP0031	RP Flat Connection Abutment 4mm	18
NP0017	NP Open Tray Transfer	14	RP0032	RP Straight Trans Mucosal Abutment 1mm	18

Catalog No.	Description	Page No.	Catalog No.	Description	Page No.
RP0033	RP Straight Trans Mucosal Abutment 2mm	18	RS3028	RS Slim Healing Abutment 3.5mmD X 3mmL	46
RP0034	RP Straight Trans Mucosal Abutment 3mm	18	RS3029	RS Slim Healing Abutment 3.5mmD X 4mmL	46
RP0043	RP Engaging Temporary Abutment	17	RS3030	RS Slim Healing Abutment 3.5mmD X 5mmL	46
RP0044	RP Non-Engaging Temporary Abutment	17	RS3031	RS Slim Healing Abutment 3.5mmD X 6mmL	46
RP0045	RP Plastic Cylinder Abutment	17	RS3095	RS Engaging Titanium / Plastic Abutment	47
RP0046	RP Slim Healing Abutment 3.5mmD x 2mmL	17	RS3097	RS Non-Engaging Titanium / Plastic Abutment	47
RP0047	RP Slim Healing Abutment 3.5mmD x 3mmL	17	RS3411	RS Straight Cylindrical Titanium Abutment 2mm	47
RP0048	RP Slim Healing Abutment 3.5mmD x 4mmL	17	RS3422	RS Non-Engaging Straight Cylindrical Titanium Abutment 2mm	47
RP0049	RP Slim Healing Abutment 3.5mmD x 5mmL	17	RS3435	RS Implant Cover Screw	51
RP0050	RP Slim Healing Abutment 3.5mmD x 6mmL	17	RS3505	RS Esthetic Connection Abutment 0.5mm	49
RP0051	RP Ball Attachment 0.5mm	19	RS3515	RS Esthetic Connection Abutment 1.5mm	49
RP0052	RP Ball Attachment 1mm	19	RS3605	RS Connection Abutment 0.5mm	49
RP0053	RP Ball Attachment 2mm	19	RS3615	RS Connection Abutment 1.5mm	49
RP0054	RP Ball Attachment 3mm	19	RS3731	RS Straight Trans Mucosal Abutment 1mm	48
RP0055	RP Ball Attachment 4mm	19	RS3732	RS Straight Trans Mucosal Abutment 2mm	48
RP0056	RP Ball Attachment 5mm	19	RS3733	RS Straight Trans Mucosal Abutment 3mm	48
RP0062	RP Handpiece Hex Adapter-Short	20,60	RS3734	RS Angled Trans Mucosal Abutment 17° 2mm	48
RP0064	Star Hand Driver-Short	20,26,60,62	RS3735	RS Angled Trans Mucosal Abutment 30° 3mm	48
RP0065	Star Torque Driver-Short	13,20,26,60,62	RS3737	RS Angled Trans Mucosal Abutment 17° 3mm	48
RP0066	RP 2.2mm Hex Torque Driver-Long	20,60,65	RS3738	RS Angled Trans Mucosal Abutment 30° 4mm	48
RP0067	RP 2.2mm Hex Torque Driver-Short	20,60,65	RS3800	RS Straight Titanium Abutment - No End Line	46
RP0072	RP Handpiece Hex Adapter-Long	20,60	RS3801	RS Straight Titanium Abutment 1mm	46
RP0090	RP Conical Healing Abutment 4.5mmD x 2mmL	17	RS3802	RS Straight Titanium Abutment 2mm	46
RP0091	RP Conical Healing Abutment 4.5mmD x 3mmL	17	RS3803	RS Straight Titanium Abutment 3mm	46
RP0092	RP Conical Healing Abutment 4.5mmD x 4mmL	17	RS3804	RS Straight Titanium Abutment 4mm	46
RP0093	RP Conical Healing Abutment 4.5mmD x 5mmL	17	RS3811	RS Straight Titanium Abutment Long 12.5mm	46
RP0094	RP Conical Healing Abutment 4.5mmD x 6mmL	17	RS3812	RS One Piece Screw-In Abutment	47
RP3095	RP Engaging Titanium/Plastic Abutment	17	RS3890	RS Wide Profile Titanium Abutment	47
RP3097	RP Non-Engaging Titanium/Plastic Abutment	18	RS3903	RS Slim Titanium Abutment 3mm	46
RP3401	RP Retrieval Screw for Abutments	21,62	RS3906	RS Slim Titanium Abutment 6mm	46
RP3734	RP Angled Trans Mucosal Abutment 17° 2.5mm	18	RS3908	RS Slim Titanium Abutment 8mm	46
RP3735	RP Angled Trans Mucosal Abutment 30° 3mm	18	RS4015	RS Angled Titanium Abutment 15°	47
RP3737	RP Angled Trans Mucosal Abutment 17° 3.5mm	18	RS4016	RS Angled Titanium Abutment 15° - Long	47
RP3738	RP Angled Trans Mucosal Abutment 30° 4mm	18	RS4025	RS Angled Titanium Abutment 25°	47
RS 3090	RS Engaging Gold/Plastic Abutment	47	RS4035	RS Angled Titanium Abutment 35°	47
RS2650	RS Ball Attachment 0.5mm	49	RS4115	RS Esthetic Angled Titanium Abutment 15° 1mm	47
RS2651	RS Ball Attachment 1 mm	49	RS4117	RS Esthetic Angled Titanium Abutment 15° 2mm	47
RS2652	RS Ball Attachment 2 mm	49	RS4119	RS Esthetic Angled Titanium Abutment 15° 3mm	47
RS2653	RS Ball Attachment 3 mm	49	RS4900	TMA Titanium Temporary Copying	48
RS2654	RS Ball Attachment 4 mm	49	RS5000	RS Engaging Plastic Cylinder Casting Abutment	47
RS2655	RS Ball Attachment 5 mm	49	RS5001	TMA Plastic Casting Sleeve w/Prosthetic Screw	48
RS2660	Plastic Ball Cap White	50	RS5004	TMA Abutment Replica	48
RS2662	Plastic Ball Cap Pink Soft	50	RS5005	TMA Healing Cap	48
RS2670	Titanium Ball Cap	50	RS5006	TMA Impression Coping Open Tray	48
RS2675-SS	Stainless Steel Ball Cap	13,19,26,50	RS5010	RS Engaging Plastic Casting Standard Abutment	47
RS2861	RS Ball Attachment 1mm	49	RS5011	TMA Closed Tray Transfer	48
RS2862	RS Ball Attachment 2mm	49	RS5020	RS Non-Engaging Plastic Cylinder Casting Abutment	47
RS2863	RS Ball Attachment 3mm	49	RS5030	RS Engaging Plastic Standard Abutment	47
RS2864	RS Ball Attachment 4mm	49	RS5040	RS Engaging Plastic Cylinder Abutment	47
RS2865	RS Ball Attachment 5mm	49	RS5050	RS Non-Engaging Plastic Standard Abutment	47
RS2866	RS Ball Attachment 6mm	49	RS5100	RS Plastic Coping Connection Abutment	49
RS3012	RS Wide Healing Abutment 6mmD x 2mmL	46	RS5509	RS Closed Tray Transfer 9mm	51
RS3014	RS Wide Healing Abutment 6mmD x 4mmL	46	RS5512	RS Closed Tray Transfer 12mm	51
RS3015	RS Wide Healing Abutment 6mmD x 5mmL	46	RS5600	RS Slim Closed Tray Transfer	51
RS3022	RS Healing Abutment 4.5mmD x 2mmL	46	RS5610	RS Open Tray Transfer	51
RS3023	RS Healing Abutment 4.5mmD x 3mmL	46	RS5615	RS Open Tray Transfer for Connection Abutment	49
RS3024	RS Healing Abutment 4.5mmD x 4mmL	46	RS5715	Implant Replica for Connection Abutment	49
RS3025	RS Healing Abutment 4.5mmD x 5mmL	46	RS5737	RS Internal Hex Implant Analog	51
RS3026	RS Healing Abutment 4.5mmD x 6mmL	46	RS5740	Ball Attachment Abutment Replica	51
RS3027	RS Slim Healing Abutment 3.5mmD X 2mmL	46	RS6011	RS 2.4 Hex Torque Driver-Short	50,62,65

Catalog No.	Description	Page No.	Catalog No.	Description	Page No.
RS6012	RS 2.4 Hex Torque Driver-Long	50,62,65	WP0050	WP Slim Healing Abutment 4mmD x 6mmL	24
RS6025	RS One Piece Torque Driver-Short	50	WP0051	WP Ball Attachment 0.5mm	26
RS6026	RS One Piece Torque Driver-Long	50	WP0052	WP Ball Attachment 1mm	26
RS6080	1.27 Hex Torque Driver-Short	50,62	WP0053	WP Ball Attachment 2mm	26
RS6082	1.27 Hex Torque Driver-Long	50,62	WP0054	WP Ball Attachment 3mm	26
RS6090	Torque Driver for Ball Attachment	14,20,27,50,62	WP0055	WP Ball Attachment 4mm	26
RS6094	1.27 Hex Hand Driver-Medium	50,62,65	WP0056	WP Ball Attachment 5mm	26
RS6095	1.27 Hex Hand Driver-Short	50,62,65	WP0062	WP Handpiece Hex Adapter-Short	27,60
RS6097	1.27 Hex Hand Driver-Long	50	WP0066	WP 2.6mm Torque Driver-Long	26,60,65
RS6100	Wrench Ratchet	60,62,64	WP0067	WP 2.6mm Torque Driver-Short	26,60,65
RS6111	Surgical Torque ratchet 35-100 Ncm	60,62,64	WP0072	WP Handpiece Hex Adapter-Long	27,60
RS6112	Prosthetic Torque ratchet 15-35Ncm	62,64	WP0090	WP Conical Healing Abutment 4.5mmD x 2mmL	24
RS6150	Parallel Pin 11	60,62,65	WP0091	WP Conical Healing Abutment 4.5mmD x 3mmL	24
RS6155	Parallel Pin 16	60,62,65	WP0092	WP Conical Healing Abutment 4.5mmD x 4mmL	24
RS6180	Depth Probe	60,62,65	WP0093	WP Conical Healing Abutment 4.5mmD x 5mmL	24
RS6191	TMA/FC Female Hand Hex Driver-Long	13,20,26,50,60,62,65	WP0094	WP Conical Healing Abutment 4.5mmD x 6mmL	24
RS6193	TMA/FC Female Hand Hex Driver-Short	13,20,26,50,60,62,65	WP3095	WP Engaging Titanium/Plastic Abutment	24
RS6194	TMA/FC Hex Handpiece Adapter-Short	14,20,27,51,62	WP3097	WP Non-Engaging Titanium/Plastic Abutment	24
RS6195	TMA/FC Hex Handpiece Adapter-Long	14,20,27,51,62	WP3401	WP Retrieval Screw for Abutments	27
RS6196	TMA/FC Hex Torque Driver-Long	14,20,27,50,62	WP3731	WP Straight Trans Mucosal Abutment 1mm	25
RS6197	TMA/FC Hex Torque Driver-Short	14,20,27,50,62	WP3732	WP Straight Trans Mucosal Abutment 2mm	25
RS6301	RS - Standard Internal Hex Plastic Surgical Kit-Premium	62	WP3733	WP Straight Trans Mucosal Abutment 3mm	25
RS6322	RS - Standard Internal Hex Plastic Surgical Kit-Advanced	62	WP3734	WP Angled Trans Mucosal Abutment 17° 2.5mm	25
RS6333	RS - Standard Internal Hex Plastic Surgical Kit-Starter	62	WP3735	WP Angled Trans Mucosal Abutment 30° 3mm	25
RS7001	Surgical Driver	64	WP3737	WP Angled Trans Mucosal Abutment 17° 3.5mm	25
RS8032	Tip Drill	60,62,63	WP3738	WP Angled Trans Mucosal Abutment 30° 4mm	25
RS9020	RS Hex Handpiece Adaptor-Short	65	ZA0005	RS Straight Zirconium Abutment w/ Titanium Base	47
RS9025	RS Hex Handpiece Adaptor-Long	65	ZA0007	RS Angled Zirconium Abutment 15° w/Titanium Base	47
RS9027	Drill Extension	65	ZA0105	NP Straight Zirconium Abutment w/Titanium Base	12
RS9030	1.27 Hex Driver for Handpiece-Short	51,62	ZA0107	NP Angled Zirconium Abutment 15° w/Titanium Base	12
RS9035	1.27 Hex Driver for Handpiece-Long	51,62	ZA0207	RP Angled Zirconium Abutment 15° w/Titanium Base	18
RS9040	Screw Type RS/WP Implant Removal Tool	65	ZA0214	RP Straight Zirconium Abutment w/Titanium Base	18
RS9041	Screw Type NP/RP Implant Removal Tool	65	ZA0307	WP Angled Zirconium Abutment 15° w/Titanium Base	25
TD1511	Three Step Drill-Short	60,62,63	ZA0314	WP Straight Zirconium Abutment w/Titanium Base	25
TD2218	Three Step Drill-Long	60,62,63			
WP0001	WP Abutment Screw	24			
WP0007	WP Implant Analog	27			
WP0010	WP Straight Abutment 3mm	24			
WP0011	WP Straight Abutment 2mm	24			
WP0012	WP Straight Abutment 1mm	24			
WP0013	WP Angled Abutment 15° 1mm	24			
WP0014	WP Angled Abutment 15° 2mm	24			
WP0015	WP Angled Abutment 15° 3mm	24			
WP0016	WP Slim Closed Tray Transfer	27			
WP0017	WP Open Tray Transfer	27			
WP0020	WP Straight Slim Abutment - No End Line	24			
WP0022	WP Healing Abutment 5.5mmD x 2mmL	24			
WP0023	WP Healing Abutment 5.5mmD x 3mmL	24			
WP0024	WP Healing Abutment 5.5mmD x 4mmL	24			
WP0025	WP Healing Abutment 5.5mmD x 5mmL	24			
WP0026	WP Healing Abutment 5.5mmD x 6mmL	24			
WP0030	WP Flat Connection Abutment 2mm	25			
WP0031	WP Flat Connection Abutment 4mm	25			
WP0043	WP Engaging Temporary Abutment	24			
WP0044	WP Non-Engaging Temporary Abutment	24			
WP0045	WP Plastic Cylinder Abutment	24			
WP0046	WP Slim Healing Abutment 4mmD x 2mmL	24			
WP0047	WP Slim Healing Abutment 4mmD x 3mmL	24			
WP0048	WP Slim Healing Abutment 4mmD x 4mmL	24			
WP0049	WP Slim Healing Abutment 4mmD x 5mmL	24			

Adin products meet and exceed the highest standards set by the FDA and other regulatory agencies. All ADIN products are CE-marked in accordance with the Council Directive 93/42/EEC and Amendment 2007/47/EC. ADIN complies with ISO 13485:2003 and the Canadian Medical Devices Conformity Assessment System (CMDACS). Product availability may vary between countries. Please contact your local ADIN office.

For regulatory purposes, item number format can be displayed either with or without a middle slash and space/s.

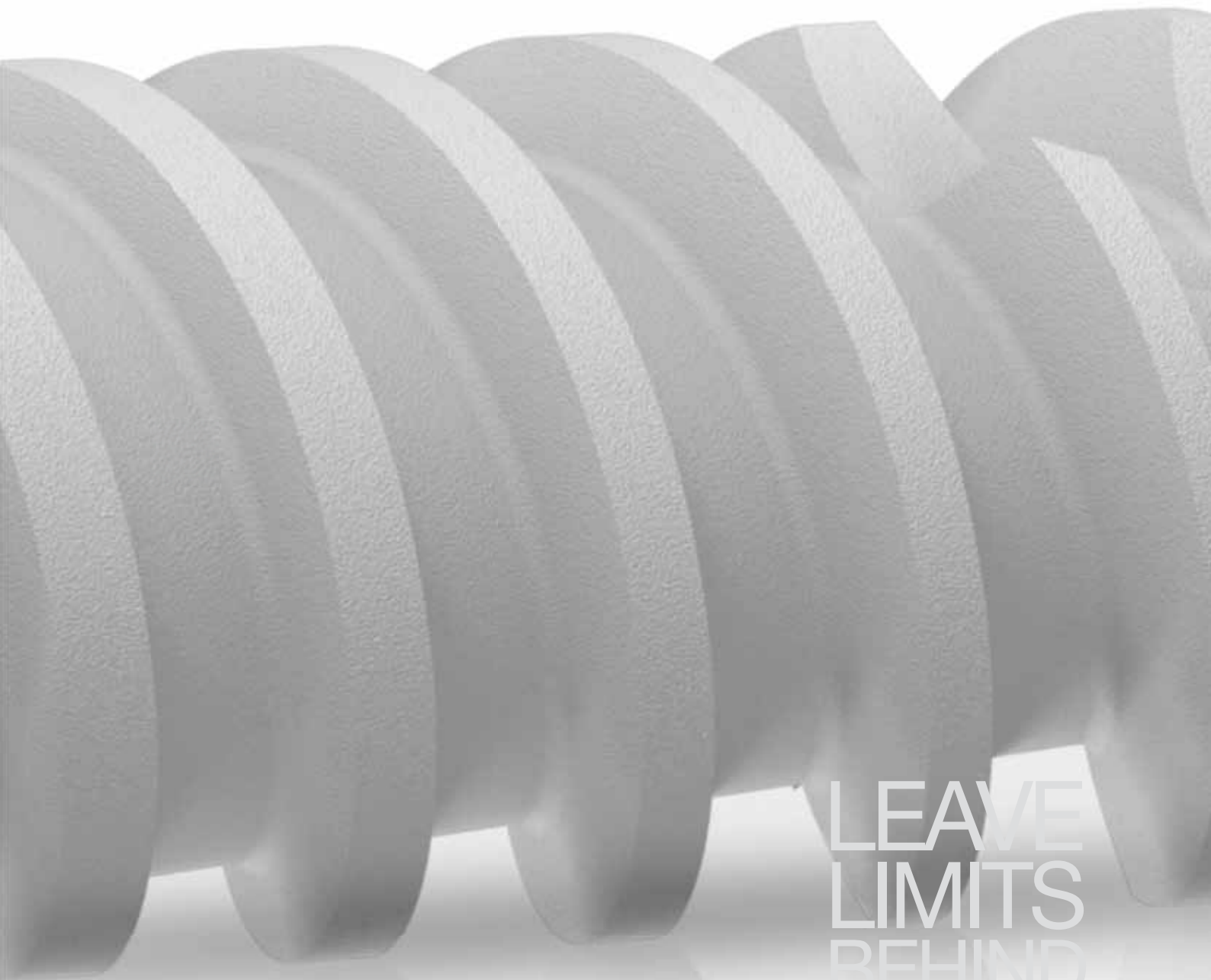

LEAVE  
LIMITS  
BEHIND

Leading You Successfully World Wide



T. +972 4 642 6732 | Industrial Park Allon Tavor  
F. +972 4 642 6733 | POB 1128 Afula 18550, Israel | [www.adin-implants.com](http://www.adin-implants.com)



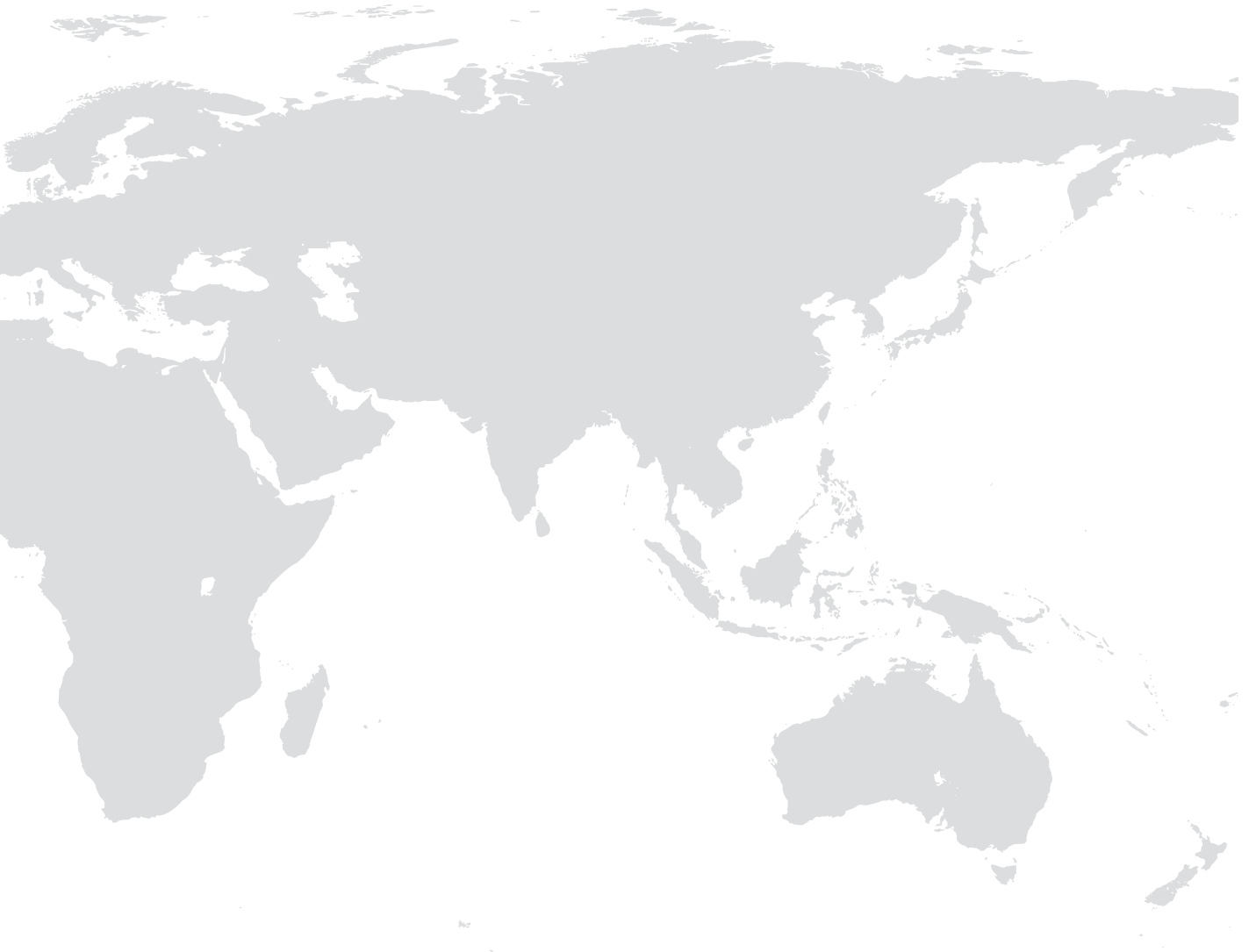

LEAVE  
LIMITS  
BEHIND



[www.adin-implants.com](http://www.adin-implants.com)